

# Operating Instructions Testomat 2000<sup>®</sup> PO4

Process Photometer for  
Phosphate 0- 10 mg/l



# Content

|  |           |
|--|-----------|
| <b>Content</b> .....   | <b>2</b>  |
| <b>Important safety information</b> .....                          | <b>4</b>  |
| Intended use .....   | 4         |
| Qualification of the staff .....                                   | 4         |
| Warning notices in these instructions .....                        | 5         |
| Further documents.....   | 5         |
| Pay particular attention to .....                                  | 5         |
| General instructions .....   | 5         |
| Installation .....   | 6         |
| Operation .....  | 6         |
| Cleaning.....  | 6         |
| After switch-off and longer downtime.....                          | 6         |
| De-installation .....  | 6         |
| Disposal .....   | 6         |
| <b>Scope of delivery</b> .....                                     | <b>7</b>  |
| <b>Performance specifications</b> .....                            | <b>7</b>  |
| <b>Application instructions</b> .....                              | <b>8</b>  |
| <b>Installation</b> .....  | <b>10</b> |
| Operating Testomat 2000® PO4 in the pressure range of 0.3 to 1 bar | 10        |
| Installing Testomat 2000® .....                                    | 10        |
| Connecting the water inlet and outlet .....                        | 11        |
| Water inlet.....   | 11        |
| Water outlet.....  | 11        |
| Connecting the power supply and devices .....                      | 12        |
| Block diagram Testomat 2000® PO4 .....                             | 12        |
| Internal design Testomat 2000® PO4 .....                           | 13        |
| Connecting the mains voltage.....                                  | 14        |
| Connecting the plant components .....                              | 15        |
| Connecting the inputs and outputs .....                            | 16        |
| <b>Commissioning</b> .....   | <b>17</b> |
| Inserting large containers (5/20 litre canister).....              | 17        |
| Inserting the reagent bottles .....                                | 17        |
| Extracting the reagent.....  | 18        |
| Input reagent level .....  | 18        |
| Opening the water inlet.....                                       | 18        |
| Instrument settings and data input.....                            | 18        |
| <b>Functions of the operating and display elements</b> .....       | <b>19</b> |
| Switching Testomat 2000® PO4 on/off .....                          | 19        |
| Display functions.....   | 19        |
| Operating elements and function keys .....                         | 21        |
| Operating system.....  | 22        |
| <b>Password protection and basic program</b> .....                 | <b>23</b> |
| Selecting the operating mode .....                                 | 23        |
| Selecting the display unit .....                                   | 25        |
| Select volume.....   | 26        |
| <b>Entering further basic program data</b> .....                   | <b>27</b> |
| Internal flushing.....   | 27        |
| External flushing .....  | 27        |
| Interval pause .....   | 28        |

|   |           |
|---|-----------|
| Limit value monitoring .....                                  | 28        |
| Hysteresis .....  | 29        |
| Switch functions of the limit value outputs LV1 and LV2 ..... | 29        |
| Switch function 0, duration .....                             | 29        |
| Switch function 1, impulse .....                              | 29        |
| Switch function 2, interval .....                             | 29        |
| Switch function 3, two-point .....                            | 30        |
| Switch function 4, Duration/inverse .....                     | 30        |
| Switch function 5, range LV1-LV2 .....                        | 30        |
| Measuring points.....   | 30        |
| Function IN1 .....  | 31        |
| Water meter .....   | 31        |
| Alarm/Message .....   | 31        |
| Function AUX.....   | 32        |
| <b>Service II .....</b>                                       | <b>33</b> |
| Calibration .....   | 33        |
| Reset operating time .....                                    | 33        |
| Maintenance interval .....                                    | 34        |
| <b>Description of the signal inputs/outputs .....</b>         | <b>35</b> |
| Interfaces (optional) .....                                   | 36        |
| Installing the interface cards SK910/RS910 .....              | 37        |
| Monitoring a measuring point.....                             | 37        |
| Monitoring of two measuring points .....                      | 37        |
| Calculation of output currents .....                          | 38        |
| Serial interface RS232 .....                                  | 38        |
| SD card data logger .....                                     | 39        |
| <b>Description of the relay outputs.....</b>                  | <b>39</b> |
| Flushing (external flush valve) .....                         | 39        |
| LV1 and LV2 limit value outputs .....                         | 39        |
| Measuring points 1 or 2 (measuring point switch-over) .....   | 40        |
| AUX (programmable function output) .....                      | 40        |
| Alarm (fault message output).....                             | 41        |
| Maintenance (output for maintenance message) .....            | 41        |
| <b>Information menu "i" .....</b>                             | <b>42</b> |
| <b>Program menu "M" .....</b>                                 | <b>43</b> |
| Structure of the basic program.....                           | 45        |
| <b>Error messages/Troubleshooting .....</b>                   | <b>46</b> |
| Further information.....                                      | 47        |
| <b>Maintenance .....</b>                                      | <b>48</b> |
| Description of maintenance work.....                          | 48        |
| Service instructions .....                                    | 49        |
| Maintenance message pump head.....                            | 50        |
| Replacing the pump head.....                                  | 50        |
| <b>Testomat 2000® PO4 spare parts and accessories .....</b>   | <b>50</b> |
| Accessories.....  | 52        |
| <b>Technical data .....</b>                                   | <b>53</b> |
| Conformity Declaration .....                                  | 54        |
| Check List Testomat 2000® .....                               | 55        |



## Important safety information

- Please read these operating instructions carefully and completely prior to working with the instrument.
- Ensure that these operating instructions are always available for all users.
- These operating instructions must always be passed on to the new owner should Testomat 2000® PO4 change hands.
- Always adhere to hazard warnings and safety information when using reagents, chemicals and cleaning agents. Please adhere to the respective safety data sheet! Download the safety data sheets for the supplied reagents at <http://www.heylanalysis.de>.

### Intended use

The process photometer Testomat 2000® PO4 is a robust wet-chemical online monitor for monitoring the phosphate content from 0 to 10 mg/l (ppm) using the photometric analysis principle. The feed water must be clear, colourless and free of undissolved particles. It is used for monitoring the process water, e.g. in the fields of industry / treated wastewater / online environmental analysis.

- Always adhere to the performance limits stated in the section entitled "Technical data".
- Always observe the application areas/application limits of the indicators and the requirements of the medium being measured.

To ensure correct and intended usage, always read and understand these instructions, especially the section entitled "Important safety information", prior to use.

The instrument is not used as intended if

- it is used in areas not specified in these instructions.
- it is used in areas which do not correspond to the ones described in these instructions.

### Qualification of the staff

Assembly and commissioning require fundamental electrical and process engineering knowledge as well as knowledge of the respective technical terms. Assembly and commissioning should therefore only be carried out by a specialist or by an authorised individual supervised by a specialist.

A specialist is someone who due to his/her technical training, know-how and experience as well as knowledge of relevant regulations can assess assigned tasks, recognise potential hazards and ensure appropriate safety measures. A specialist should always adhere to the relevant technical regulations.

## Warning notices in these instructions

The warning notices in these instructions warn the user about potential dangers to individuals and property resulting from incorrect handling of the instrument. The warning notices are structured as follows:



---

### Description of the type or source of danger

Description of the consequences resulting from non-observance

- Preventive measures. Always adhere to these preventive measures.
- 

“**DANGER**” indicates an immediate hazardous situation which, if not avoided, will result in death or serious injury.

“**WARNING**” indicates a potentially hazardous situation which, if not avoided, could result in death or serious injury.

“**CAUTION**” indicates a potentially hazardous situation which, if not avoided, could result in minor or moderate injuries or property damage.

“**NOTE**” indicates important information. If this information is not observed, it may result in an undesirable result or state.

## Further documents

Testomat 2000® PO4 is a plant component. Therefore, always observe the maintenance manual of Testomat 2000® / Testomat ECO® and the documentation of the plant manufacturer.

## Pay particular attention to

### General instructions



- Adhere to health and safety regulations, electrical equipment safety regulations, and environmental protection regulations valid in the country of use and at the installation site.
- Adhere to national and local regulations during installation and commissioning.
- Always protect the instrument against moisture and humidity. It should never come into contact with condensation or splash water.
- Do not carry out any changes or modifications at the instrument which are not described in these instructions; failure to adhere to these instructions will negatively affect any warranty claims that you make thereafter.

**WARNING****NOTE**

## Installation

- Always completely disconnect the relevant plant part before installing the instrument or connecting/disconnecting it to/from the power supply. Secure the plant against reconnection.
- Only connect the instrument to the mains voltage specified on the rating plate.
- Always observe technical data and ambient parameters.
- Testomat 2000® PO4 requires an interference free and stable power supply. If necessary, use a mains filter to protect Testomat 2000® PO4 against interference voltages caused, e.g., by solenoid valves or large motors. Never lay connecting cables parallel to power cables.

## Operation

- Ensure that the maximum electrical load capacity of the relay outputs is never exceeded.
- Immediately switch off Testomat 2000® PO4 and contact service staff if malfunctioning occurs. The warranty will be void if you tamper with or attempt to repair Testomat 2000® PO4. Repairs must be carried out by authorised service staff.

## Cleaning

- Only use a dry, lint-free cloth for cleaning.

## After switch-off and longer downtime

- Ventilate the indicator leads as described in the start-up, because longer downtimes (more than 6 hours) can cause the indicator in the leads to retract.
- Do not switch off the appliance for longer periods (e.g. over the weekend) via the start/stop output. The indicator can retract from the leads. This results in measurement errors after the appliance is switched on.

## De-installation

- Prior to de-installing a defective instrument, always write down a description of the error (failure effect). It is only possible to repair a defective instrument (irrespective of the warranty period) if it has been de-installed and returned to us with a description of the error.

## Disposal

- Dispose of the instrument in accordance with national regulations.

## Scope of delivery

1x Testomat 2000® PO4

2 screw caps with hole. Used for reagent bottles

1x operating instructions

## Performance specifications

The process photometer Testomat 2000® PO4 is a robust wet-chemical online monitor for monitoring the phosphate content from 0 to 10 mg/l (ppm) using the photometric analysis principle. Analysis is carried out by adding two reagents and the analysis result is displayed after a reaction time of ten minutes.

- Measuring range: 0 – 10 mg/l with a resolution of:
  - 0,1 mg/l in the range of 0 – 7 mg/l
  - 0,25 mg/l in the range of 7 – 10 mg/lLimit of detection: 0,1 or 0,25 mg/l depending on range  
Accuracy: < 10% at end of measuring range
- Freely selectable unit in ppm or mg/l
- Analysis initiation:
  - Automatic interval operation  
(Interval pause adjustable from 0 to 255 minutes)
  - External control
  - Volume controlled (water meter)
- Two independent limit values with hysteresis (1, 2 or 3 bad analyses) and adjustable switch functions
- Monitoring of two measuring points (change-over via external solenoid valves)
- Internal error documentation
- Programmable service address
- Programmable maintenance interval for a maintenance request
- Container volume can be varied between bottle with 500 ml capacity and container with 20/5 litre capacity (a set with two screw caps with suction lance is available to connect both containers)
- **optional**
  - Interface (0/4-20 mA or 0/2-10 V) or
  - Interface RS 232 for a log printer or
  - SD card data logger

## Application instructions

- Wait at least 5 seconds before switching the instrument on and then off again at the main switch.
- In order for Testomat 2000® PO4 to operate reliably, use Heyl Testomat 2000® reagents.
- Make sure that the water is not more acidic than pH 4. At lower pH values, the hose connections and other plastic parts of the device can be damaged.
- If the measuring water contains more than 20 mg/l CO<sub>2</sub> (carbonic acid), incorrect evaluations cannot be excluded.
- Careful handling of the instrument increases both its operational reliability and service life! Therefore, carry out a visual inspection at regular intervals as described below:
  - Has the use-by-date of the indicator expired?
  - Are the hose connections of the dosing pump free of leaks?
  - Are all the water connections free of leaks?
  - Are the doors of the instrument closed properly?
  - Is the instrument heavily soiled?
  - Are the measuring chamber and the drain duct/drain hose clean?
- Trouble-free operation is only possible when maintenance is carried out on a regular basis! For more information, please refer to the section entitled "Maintenance" and the "Maintenance manual of Testomat 2000®/Testomat ECO®".
- If problems occur, please refer to the section entitled "Error messages/Troubleshooting".

### NOTE

#### Dosing of high viscosity fluids

Fluids with a high viscosity can cause problems with the dosage. The amount of liquid which is dosed may be too small.

- At a high viscosity, check if enough liquid is dosed.

Watch out for a constant temperature in the measuring room, since different temperatures can lead to different dosages.

#### Operating height of the suction lance for large indicator containers

When large indicator containers (e.g. containers with 20 litre capacity) and suction lances of the relevant length are used, the height difference between the suction pipe and the device should not exceed 1.2 metres. The precision of the measurements cannot be maintained for greater heights.



### CAUTION



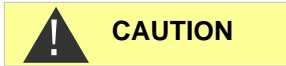

---

**No opening of the measuring chamber holder!**

Do not open the measuring chamber holder. You cannot carry out any repairs in this area, but damage the device. If you open the measuring chamber holder, your warranty will expire.

---

## Installation



### Risks resulting from incorrect installation!

- Install Testomat 2000® PO4 at a location where it is protected against dripping or splash water, dust and aggressive substances – e.g. in a switch cabinet or on a suitable wall.

### Information for trouble-free operation

- Install Testomat 2000® PO4 vertically and without mechanical stress.
- Install Testomat 2000® PO4 at a vibration-free site.

## Operating Testomat 2000® PO4 in the pressure range of 0.3 to 1 bar

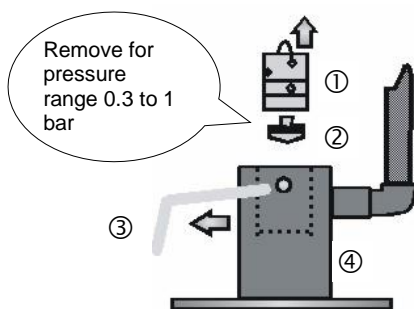

Prior to installation, please check whether lower operating pressure is required. The instrument is factory set for the operating range of 1 to 8 bar. Remove the flow controller valve body ② to operate the instrument in the operating range of 0.3 to 1 bar (e.g. when using an aerator type R). This involves removing the retaining pin ③ from the controller/filter receiver ④. Subsequently use the metal bracket to remove the controller plug ① from the borehole. Then remove the flow controller valve body ② and reinsert the controller plug and the retaining pin.

## Installing Testomat 2000®

Select an installation site where the water inlet hose can be kept as short as possible (max. 5 m).

- Please leave sufficient space on the left-hand side of the instrument to open the door.
- Drill the mounting holes as shown in the drawing on the left.
- Use three screws to attach the instrument at a suitable position in the switch cabinet or on a wall.

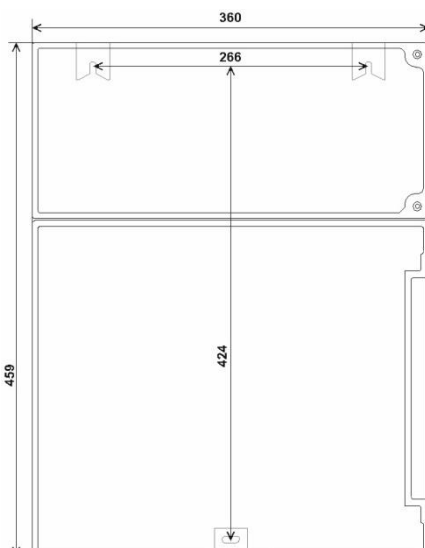

## Connecting the water inlet and outlet

### NOTE

#### Information for trouble-free operation

- The water pressure must be between 0.3 bar and 8 bar
- Avoid strong pressure fluctuations
- The measuring water temperature must be between 5 °C and 30 °C
- For temperatures above 40 °C, a cooler should be installed in the branch line of Testomat 2000® PO4.

#### Water inlet

The measuring water is taken from the main water line of the water treatment plant and fed to the inlet connection of Testomat 2000® PO4. The instrument is equipped with a plug connector for plastic hoses 6/4 x 1 (external diameter 6 mm/ internal diameter 4 mm, wall thickness 1 mm) as standard.

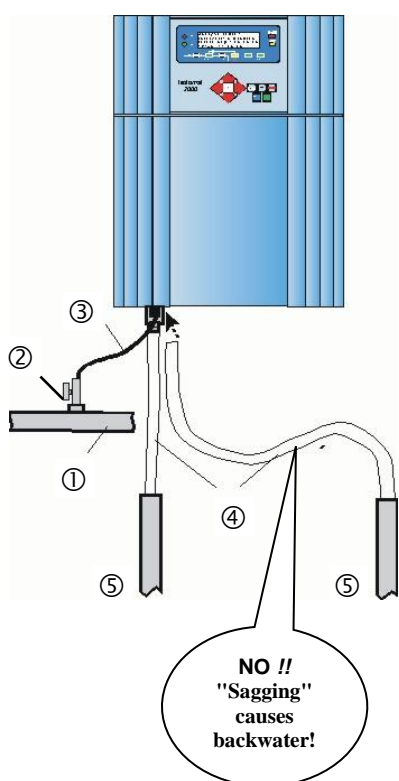

- Install the connection for the branch line of Testomat 2000® PO4 directly at the main water line ① directly after the water treatment plant
- It is important that the branch line connection is laid vertically upwards in order to prevent dirt particles from entering the instrument from the main water line.
- Install a manually operated shut-off valve ② in the branch to Testomat 2000® PO4.
- Use an opaque plastic hose 6/4 x 1 (max. length 5 m) for the water inlet ③.
- Flush the inlet to remove any dirt particles.

When operating within a pressure range of 0.3 to 1 bar or with a supply via a booster pump, please remove the valve body from the controller and the filter housing. The pump should have a feeding capacity of between 25 and 35 litres/hour and be resistant to the medium being measured.

### CAUTION

#### When using a cooler

- The hot water can cause burns and damage wetted parts of Testomat 2000® PO4.

#### Water outlet

The feed water flows through the measuring chamber to the drain via the outlet hose.

- Connect the outlet connection of Testomat 2000® PO4 to an outlet hose ④ (internal diameter 12 mm).
- Lay this hose **without backwater development** and any syphoning effect, e.g. via an open funnel, to the drain ⑤.

## Connecting the power supply and devices



### Risk of electric shocks during installation!

If the power supply is not disconnected prior to installation, it may result in personal injuries, destruction of the product or damage to plant parts.

- Always disconnect the relevant plant parts before installing Testomat 2000® PO4.
- Only use tested cables with sufficient cross-sections for the connections.



### Risk of damages caused by electromagnetic fields!

- If Testomat 2000® PO4 or the connecting cables are installed parallel to power cables or in close proximity to electromagnetic fields, the instrument may be damaged or measurements incorrect.
- Ensure that connecting cables are as short as possible.
- Always install connecting cables and power cables separately.
- Connect the instrument to the protective earth conductor (for 230/115 VAC).
- Protect Testomat 2000® PO4 against interference voltages – e.g. by using a mains filter.
- Shield the instrument against strong electromagnetic fields.

## Block diagram Testomat 2000® PO4

Drawn relay positions: Instrument de-energised

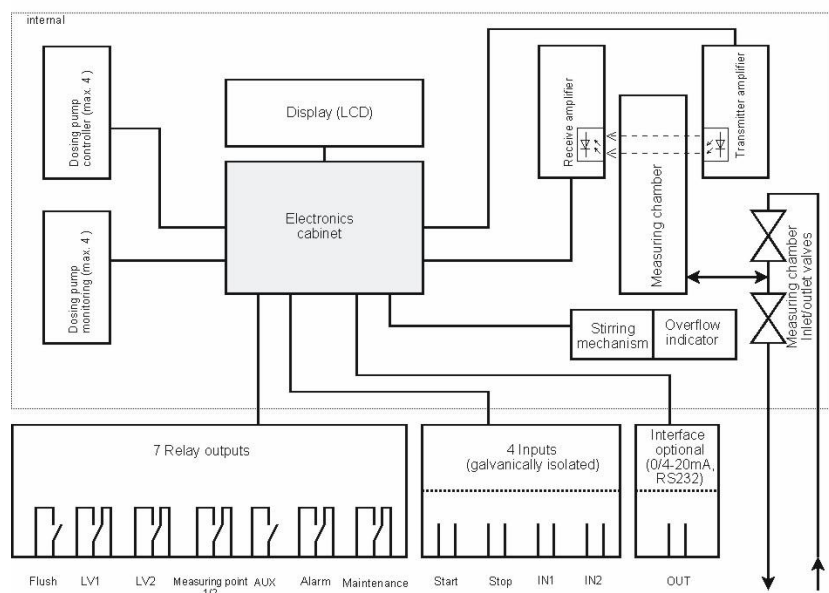

### Internal design Testomat 2000® PO4

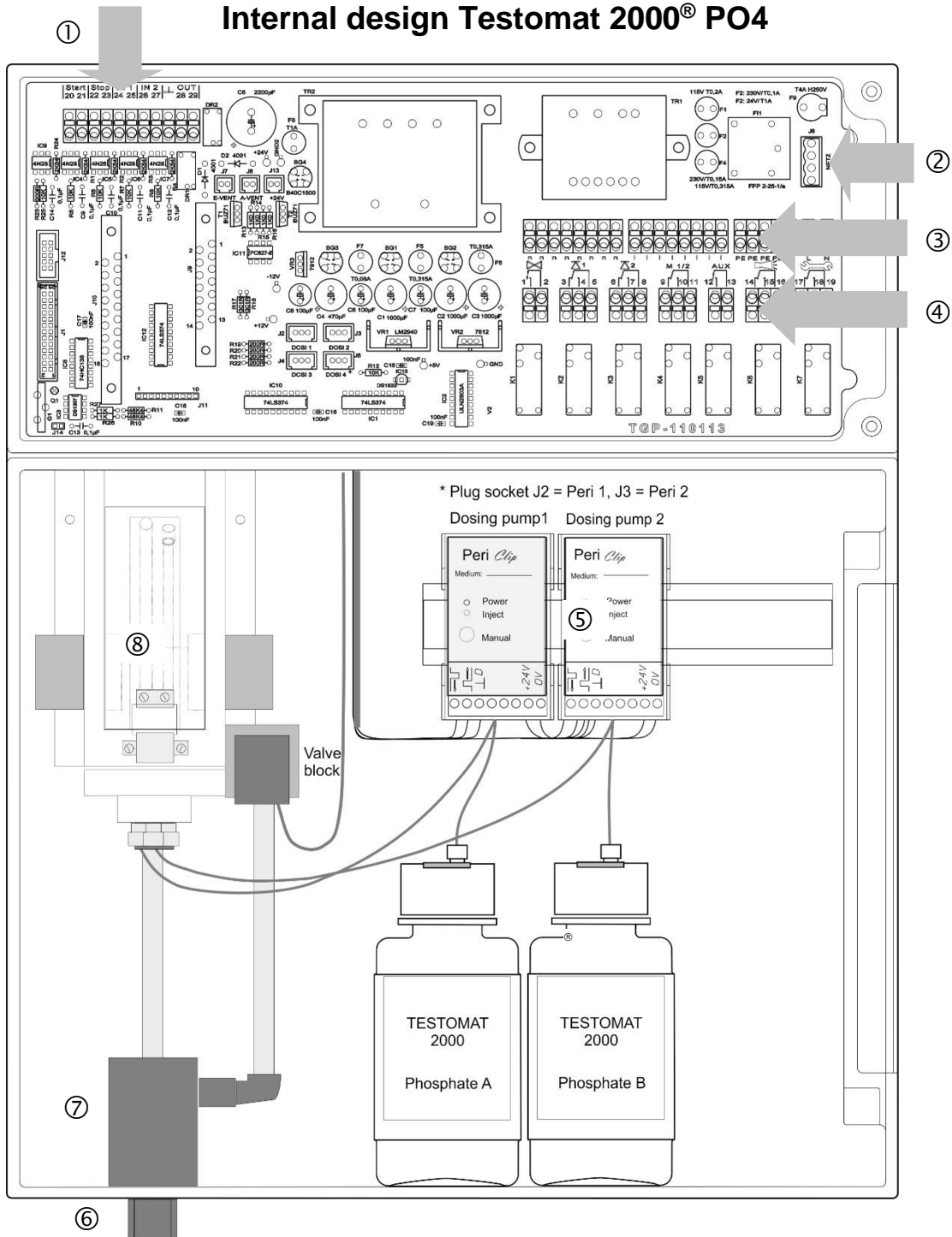

|   |   |
|---|---|
| ① | Terminal strip for inputs Start, Stop, IN1, IN2, and output OUT |
| ② | Mains switch  |
| ③ | Terminal strip for power input and power output                 |
| ④ | Terminal strip for relay outputs                                |
| ⑤ | Dosing pump   |
| ⑥ | Water connections, inlet and outlet                             |
| ⑦ | Controller / Filter receiver                                    |
| ⑧ | Measuring chamber   |



### Connecting the mains voltage

Only connect the instrument to the specified mains voltage. Refer to the rating plate for the appropriate mains voltage. Connect the cables as follows:

- Loosen both fastening screws ① and open the upper door. The terminal box is now accessible.
- Pierce the required rubber cable glands ② with a screwdriver and insert the cable through the bush into the terminal box (1)
- Subsequently pull back the cable until the bush has been turned over (2).
- Connect the power supply to terminals PE, N, L or for 24 V instruments to terminals U, V.
- Connect the conductor to the terminal block as shown on the left ③.
- Ensure that the leads are held securely in the terminals.
- Proceed as shown in figure ④ to loosen the connection.

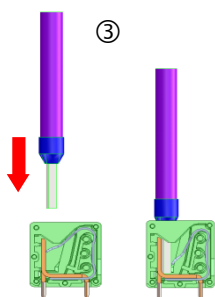
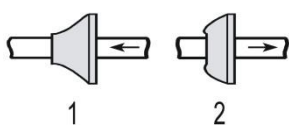

Insert the conductor with ferrule or the solid conductor into the round input.

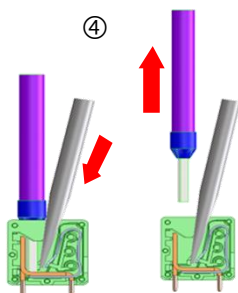

1. Insert a screwdriver into the square opening without force in order to open the terminal.
2. Once the terminal has been opened, remove the conductor.

| Terminal       | Type | Function   | Comment                          |
|----------------|------|--|----------------------------------|
| PE             | IN   | Protective earth conductor (5x)                                  | Only for mains 115/230 V !       |
| N (U)<br>L (V) | IN   | Mains, N= neutral conductor (U=24 V)<br>Mains, L= phase (V=24 V) | Mains input 24 V / 115 V / 230 V |
| n<br>I         | OUT  | Neutral, switched (8x)<br>Phase, switched (8x)                   | Mains for consumers max. 4 A     |

**Connection example**

Limit value contact LV 1 switches mains voltage

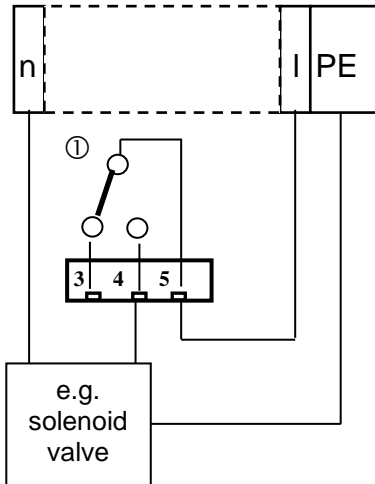

**Connecting the plant components**

- Connect the plant components to the output terminals of relays 1 to 19 (e.g. valves).
- If the plant components require mains voltage, connect the switched mains voltage (I) to the common contact ① of the respective relay (see the connection example for 230 VAC on the left).
- Connect the neutral conductor of the plant component to one of the terminals (n).
- For components with a protective earth conductor connection, connect it to the PE connection.
- Ensure that the leads are held securely in the terminals.

| No.            | Terminal             | Type | Function  | Comment                                  |
|----------------|----------------------|------|---|--|
| 1<br>2         | <b>Flush</b>         | OUT  | External flush valve  | Isolated relay output, max. 240 VAC, 4 A |
| 3<br>4<br>5    | <b>LV1</b>           | OUT  | Limit value output 1 – N/C<br>Limit value output 1 – N/O<br>Limit value output 1 - Common | Isolated relay output, max. 240 VAC, 4 A |
| 6<br>7<br>8    | <b>LV2</b>           | OUT  | Limit value output 2 – N/C<br>Limit value output 2 – N/O<br>Limit value output 2 - Common | Isolated relay output, max. 240 VAC, 4 A |
| 9<br>10<br>11  | <b>M. point. 1/2</b> | OUT  | Measuring point 1 – N/C<br>Measuring point 2 – N/O<br>M. point switch-over - Common       | Isolated relay output, max. 240 VAC, 4 A |
| 12<br>13       | <b>AUX</b>           | OUT  | Universal output  | Isolated relay output, max. 240 VAC, 4 A |
| 14<br>15<br>16 | <b>Alarm</b>         | OUT  | Fault message output – N/C<br>Fault message output – N/O<br>Fault message output - Common | Isolated relay output, max. 240 VAC, 4 A |
| 17<br>18<br>19 | <b>Maintenance</b>   | OUT  | Maintenance message – N/C<br>Maintenance message – N/O<br>Maintenance message - Common    | Isolated relay output, max. 240 VAC, 4 A |

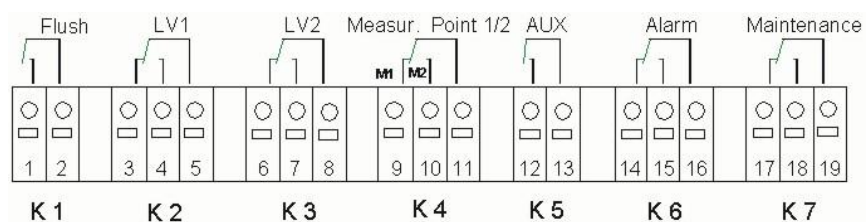

## Connecting the inputs and outputs

Testomat 2000® PO4 has the following connections for control and monitoring functions.

- Do not connect an external voltage to these connections!
- Ensure that the leads are held securely in the terminals.
- Use the two fastening screws to close the upper door once installation has been completed.

| No.           | Terminal     | Type | Function   | Comment   |
|---------------|--------------|------|--|---|
| 20<br>21      | <b>Start</b> | IN   | External analysis start<br>common earth for inputs                       | Only connect isolated normally open contact!        |
| 22<br>23      | <b>Stop</b>  | IN   | External analysis stop<br>common earth for inputs                        | Only connect isolated normally closed/open contact! |
| 24<br>25      | <b>IN1</b>   | IN   | Universal input 1<br>common earth for inputs                             | Only connect isolated normally closed/open contact! |
| 26<br>27      | <b>IN2</b>   | IN   | Universal input 2 (water meter)<br>common earth for inputs               | Only connect isolated normally open contact!        |
| ⊥<br>28<br>29 | <b>OUT</b>   | OUT  | Earth<br>0/4 - 20 mA galvanically separated<br>or serial interface RS232 | Earth = ⊥<br>28 = (+) or (TxD)<br>29 = (-) or (RxD) |

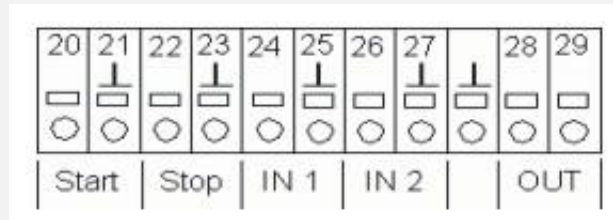

For more information, please refer to the section entitled "Description of the signal inputs/outputs".



## Commissioning



### Handling of reagents/indicators

- Adhere to the respective safety data sheet!
- Trouble-free operation of Testomat 2000® PO4 is only guaranteed when using Heyl Testomat 2000® PO4 reagents!

Connect the reagents according to the description for your container size.

### Inserting large containers (5/20 litre canister)

- Open the lower housing door by pulling on the right side.
- Put the canisters under the device.
- Remove the caps from the canisters.
- Insert one suction lance into each canister.

#### Note the length of the suction lances!

The shorter suction lance (Part No. 40536) is for the 5 litre canister (B) (Reagent B), the longer suction lance (Item No. 40535) is for the 20 litre canister (A) (Reagent A).

- Hand-tighten the screw caps of the suction lances onto the canisters.
- Guide the suction lances through the cable ducts (C) on the right side of the housing wall.
- Insert the suction hose by hand into the hose connector of the insert (D).  
Pay attention to ensure the correct assignment of reagents A (20 l) and B (5 l) to the dosing pumps: **A = left, B = right**
- In the basic program under Program values -> Volume, select 20/5l canister.

### Inserting the reagent bottles

- Open the lower housing door by pulling on the right-hand side.
- Remove the cap from the indicator bottle.
- Remove the plastic bag from inside the lower housing door. The plastic bag contains the screw cap with hole ① and the insert ② for the screw cap for each bottle.
- Place the insert ② into the bottle ④.
- Screw the screw cap with hole ① hand-tight onto the bottle ④.
- Place the bottle underneath the dosing pump. Observe correct allocation of the reagents A and B to the dosing pumps: **A = left, B = right.**
- Push the intake hose ③ hand-tight onto the hose connector of the insert ②.

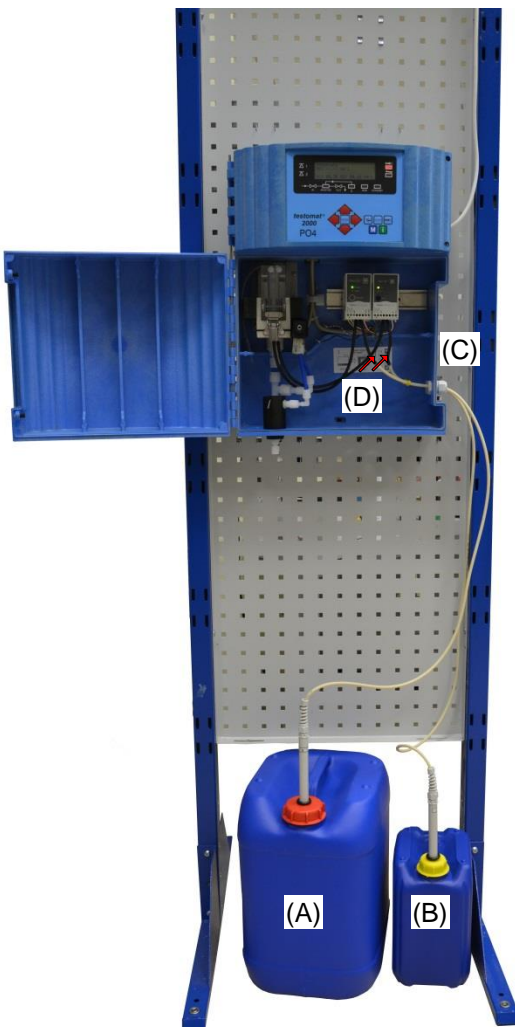

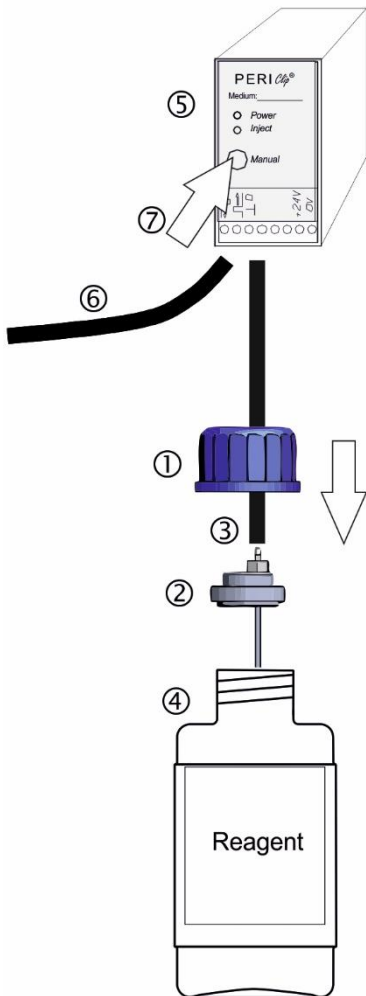

## Extracting the reagent

- Switch the instrument on and press the "STANDBY" key.
- During operation, the pump (PERIClip) ⑤ automatically extracts reagent.
- To ensure that reagent is available for the initial analyses, the intake hose ③ and the transport hose ⑥ must be filled with indicator from the pump up to the measuring chamber.
- Press the "manual" ⑦ key several times until the intake hose ③ and the transport hose ⑥ are filled up to the measuring chamber.
- If necessary, manually tighten the hose connectors of the intake and transport hose slightly in case of bubble formation.

## Input reagent level

- In the program menu M select >Service I -> Input Reagents
- Set the reagent levels to 100%.
- Press ENTER to confirm the selection.

## Opening the water inlet

- Open the lower housing cover.
- Slowly open the manually operated shut-off valve to prevent the measuring chamber overflowing. The flow regulator requires a few seconds to function correctly.
- Make sure that the water conducting parts are not leaky.
- If water sprays from the hose ⑧ of the measuring chamber ⑨, reduce the amount of inlet water via the manually operated shut-off valve. It should take 2 to 6 seconds to fill the measuring chamber!

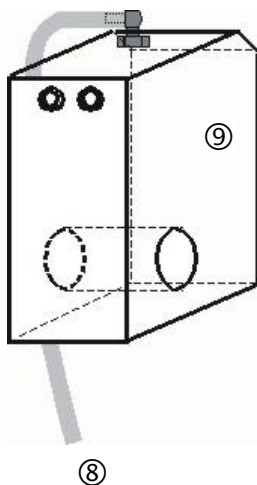

## Instrument settings and data input

Please read the following information before carrying out settings and entering data for operating the instrument.

## Functions of the operating and display elements

The Testomat 2000® PO4 display shows operating statuses and measured values. The input keys for programming (cursor block) and the function keys are located underneath the display.

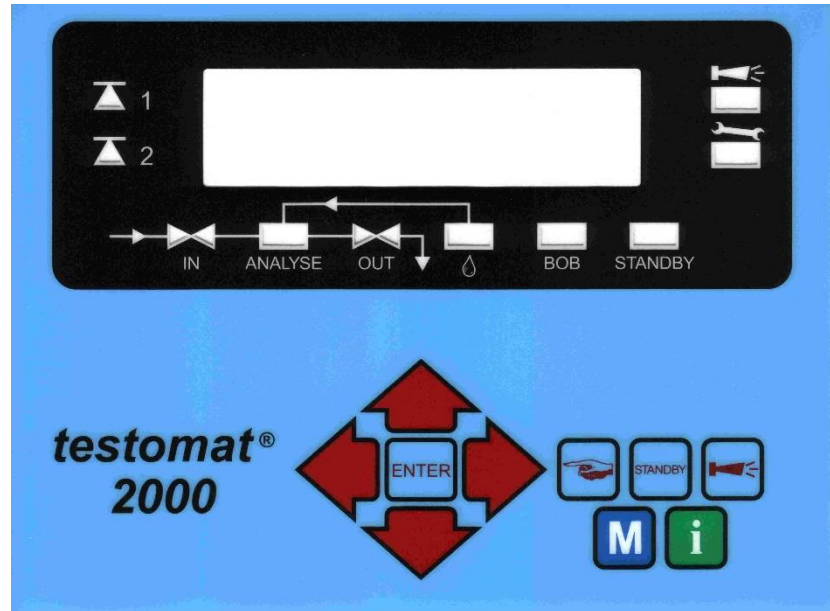

### Switching Testomat 2000® PO4 on/off



- (1) Mains switch  
Use this switch to switch the instrument on or off.

- (2) Instrument fuse (inside the instrument)  
This fuse protects Testomat 2000® PO4 and the outputs against overloads and short circuits.

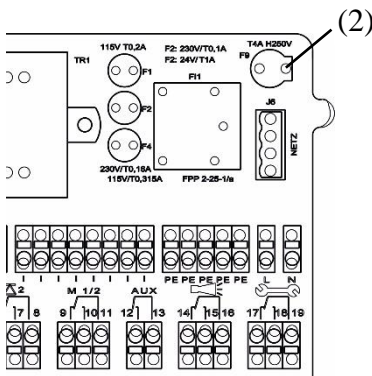

## Display functions

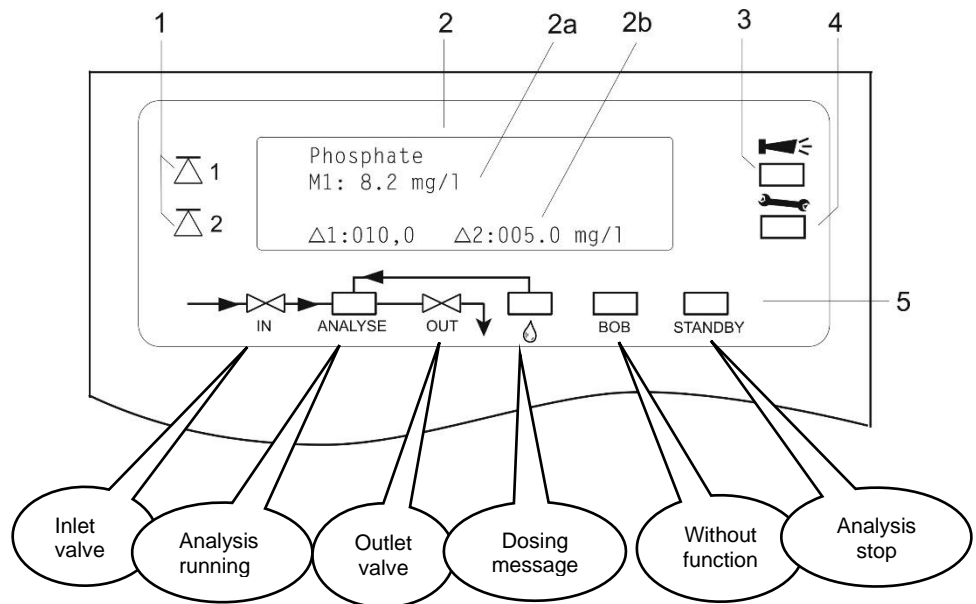

### 1 Limit value status displays (red/green)

The display 1 illuminates red if limit value 1 has been reached or exceeded. The display 1 illuminates green if the value falls below the limit value. The same principle applies to limit value 2 and display 2. Behaviour is completely opposite with switch function 4. With switch function 5 both displays illuminate green if the measured value is within the range of LV1 and LV2.

### 2 Text display (4 lines)

Displays the current analysis result as well as all important statuses and programming data.

2a = The current measured value for measuring point 1 (M1) and 2 (M2) is displayed in line 2 and 3.

Value exceeds the measuring range = ">" e.g. M1: >10 mg/l

2b = The set limit values LV1 and LV2 are displayed in line 4

### 3 Alarm (red)

Indicates malfunctioning/error message or warning message.

### 4 Maintenance message (yellow)

Indicates current maintenance requests

### 5 Status display of the active instrument components (line)

Six displays indicate the current instrument and analysis status

All error and warning messages are alternately shown in line 1 of the standard display!

## NOTE



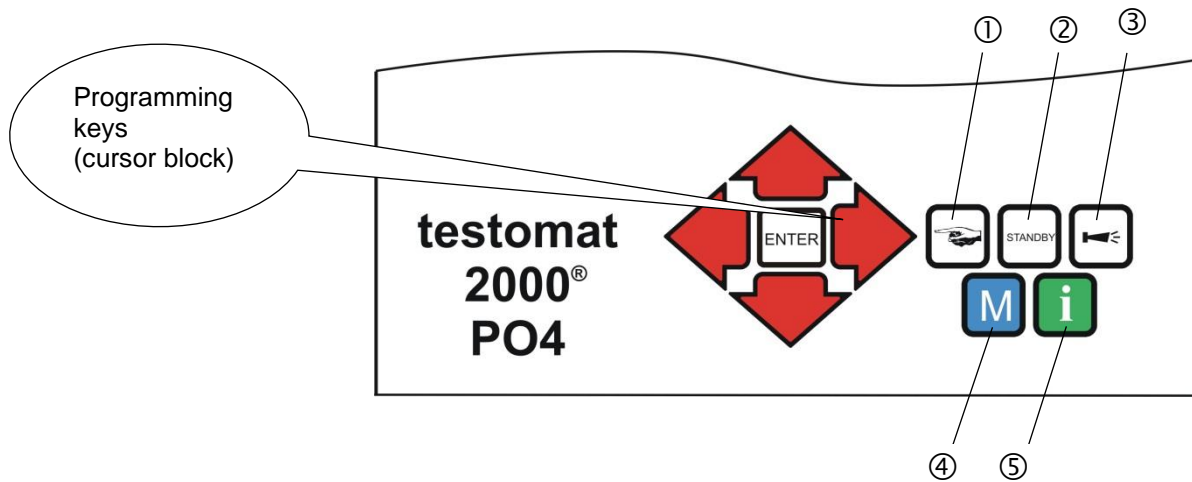

### Cancelling error messages/warning messages

- Press  to acknowledge the message and, if necessary, eliminate the cause of the fault.

## Operating elements and function keys



### Function keys

|   |  |
|---|--|
|    | Press the <b>"manual"</b> key ① to start an analysis by hand   |
|  | Press the <b>"STANDBY"</b> key ② to put the instrument into standby mode (automatic analyses are not carried out: analysis stop) |
|  | Press the <b>"Horn"</b> key ③ to acknowledge error and warning messages  |
|  | Press the <b>"M"</b> key ④ to open the programming menu for user specific and instrument specific settings                       |
|  | Press the <b>"i"</b> key ⑤ to call all instrument information and settings   |

(M)enu key



Cursor block



If you wish to carry out settings or enter data, or if alterations are necessary, press the **"M" key** to open the programming mode. Use this key when *in the menu* to go to the higher order menu items or to exit the programming mode. Please note: The basic program is password protected!

### Programming keys (cursor block)

Use the programming keys (cursor block) to navigate in the menu, to select the desired functions and to enter necessary instrument and plant specific data. Press the "ENTER" key to select the submenu item and to confirm and accept the selection or data input.

Testomat instrument  
(display) in display mode

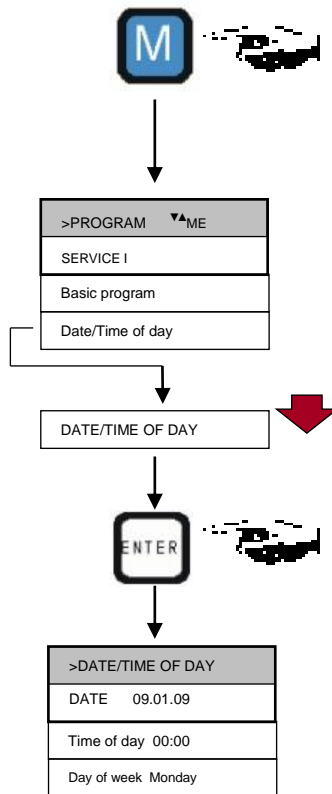

## Operating system

Instrument settings and data input

Date, time and weekday input

- Press the "M" key

The basic menu ">PROGRAM" appears

- Use the cursor block to select the desired menu item "Date/Time of day"

The selection appears in CAPITAL LETTERS.

- Press "ENTER" to confirm your selection

The selected submenu ">DATE/TIME of day" appears

The menu item "DATE" has already been selected (capital letters)

- Press "ENTER" to confirm the menu item "DATE"

The cursor flashes in the date field: "■9.01.09"

- Use the cursor keys to select the desired number
- Use the keys to move the cursor to the next input field
- Repeat this input process until the year has been entered
- Press "ENTER" to confirm the entry

The date has now been entered.

Exit the menu item "DATE" in order to set the time.

- Use the cursor block to select the desired menu item "TIME OF DAY"
- Press "ENTER" to confirm your selection

The cursor flashes at the first position of the time: "■0:00"

- Use the cursor keys to select the desired number
- Use the keys to move the cursor to the next input field
- Repeat this input process until the seconds have been entered
- Press "ENTER" to confirm the entry

The time has now been entered.

Exit the menu item "TIME OF DAY" to set the weekday

- Use the cursor block to select the desired menu item "DAY OF WEEK"
- Press "ENTER" to confirm your selection
- Use the cursor block to select the selected weekday
- Press "ENTER" to confirm the entry
- Press the "M" key twice to end programming

The standard measured value display appears on the display

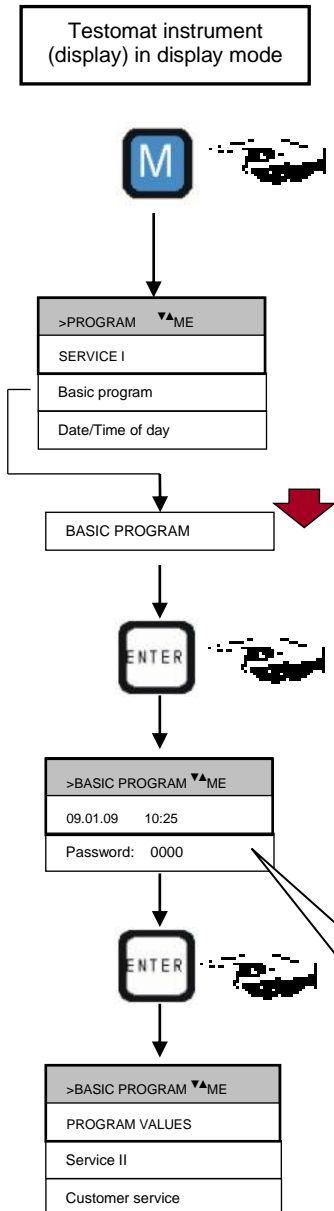

## Password protection and basic program

A four-digit password is required to enter data and to carry out settings in the basic program. The password is the current time of Testomat 2000® in reverse order.

### Password entry

- Press the "M" key
  - The basic menu ">PROGRAM" appears
- Use the cursor block to select the desired menu item "Basic program"
  - The selection appears in CAPITAL LETTERS.
- Press "ENTER" to confirm your selection
  - The selected submenu ">BASIC PROGRAM" appears
- Press "ENTER" to confirm the menu item "BASIC PROGRAM"
  - The cursor flashes in the "Password:" field █000
- Use the cursor keys to enter the time in *reverse order*: "5201"
- Press "ENTER" to confirm the entry

The selection menu for the basic program appears. You can now enter the plant specific data.

Please enter the time in reverse order:  
=> 5201

**Time controlled**  
Internal start via a timer.

|                        |
|------------------------|
| >MODE OF OPERATION ▲ME |
| TIME CONTROLLED *      |
| Volume interval        |
| Dynamics               |
| External (Start)       |

## Selecting the operating mode

Under the menu item "Mode of Operation" it is possible to select the type of analysis controller. Testomat 2000® PO4 provides numerous selection options: Time control, quantity control via water meter and external analysis start.

Shortest interval = 0 minutes between analyses. Largest interval = 255 minutes.

The analysis interval (time between two analyses) is determined by the duration of the supplementary program AUX, the set flush times (internal and external), the programmed interval and the duration of the analysis.

### Selecting the time control

- In >BASIC PROGRAM, select
  - => PROGRAM VALUES=> MODE OF OPERATION=> TIME CONTROLLED
- Press "ENTER" to confirm the selection
  - (An asterisk " \* " appears at the end of the line)
  - ("TIME CONTROLLED" " \* " is preset)

|                             |
|-----------------------------|
| >FLUSH TIMES/INTERVAL ▼▲ ME |
| INTERNAL FLUSH TIME 000s    |
| External flush time 00s     |
| Interval pause 001m         |

Enter the interval pause and the flush times

- In >BASIC PROGRAM, select
  - => PROGRAM VALUES=> FLUSH TIMES/INTERVAL
  - => INTERVAL PAUSE
- Enter the "INTERVAL PAUSE" in minutes (m) (1 minute is preset)
- Enter the "INTERNAL FLUSH TIME" in seconds (s) (000 seconds (s) is preset)
- Enter the "EXTERNAL FLUSH TIME" in seconds (s) (00 seconds (s) is preset)
- Press "ENTER" to complete all the entries

**Analysis interval**

Sequence of times

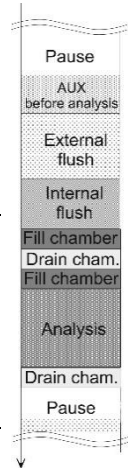

**Duration of the analysis interval**

- The analysis interval is the addition of the "AUX before analysis", "Internal flush" and "External flush" times and the measuring value dependent analysis duration (see diagram on the left)

|                          |
|--------------------------|
| <b>Volume controlled</b> |
| Start via water meter    |

Minimum interval = 1 litre, maximum interval = 9999 litres. The analysis is carried out once the programmed water quantity has been measured. The line and the measuring chamber are flushed prior to the analysis (observe the programmed flush times).

|                        |
|------------------------|
| >VOLUME INTERVAL ▼▲ ME |
| 0000l                  |
|                        |
|                        |

**Selecting the volume control**

- In >BASIC PROGRAM, select
    - => PROGRAM VALUES=> MODE OF OPERATION=> VOLUME INTERVAL
  - Press "ENTER" to confirm the selection
- The menu on the left appears.
- Enter the respective flow rate in litres
  - Press "ENTER" to confirm the entry

|                            |
|----------------------------|
| >TYPE OF WATER METER ▼▲ ME |
| 1 LITRE/IMPULSE            |
| 2,5 Litres/Impulse         |
| 5 Litres/Impulse           |
| 10 Litres/Impulse          |
| 100 Litres/Impulse *       |
| 500 Litres/Impulse         |
| 1000 Litres/Impulse        |

**Selecting the type of water meter**

- Select the >BASIC PROGRAM menu
  - =>PROGRAM VALUES=> WATER METER=> TYPE OF WATER METER
- Select the water meter constant (litre/impulse) (100 litres/impulse " \* " is factory set)
- Press "ENTER" to confirm the selection



**Volumen control /  
Time priority**

|                          |   |
|--------------------------|---|
| >MODE OF OPERATION *▲ ME |   |
| TIME CONTROLLED          | * |
| Volume interval          | * |
| External (Start)         |   |

The analysis is carried out once the programmed water quantity has been measured. An analysis is always triggered with higher priority when the programmed interval time has been reached.

**Selecting the volume control/time priority**

- The process is the same as for "Selecting the time control"
- The process is the same as for "Selecting the volume control"
- Press "ENTER" to confirm all the entries

**External  
analysis start**

**External analysis start**

External analysis start occurs via a contact at the **start input**.

Note: The current analysis interval can be interrupted by triggering a contact at the **stop input**.

**Analysis  
interval**

Sequence of  
times

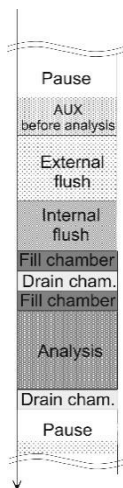

**Typical analysis cycle**

1. Flush the measuring chamber and line
2. Fill the measuring chamber
3. Check the sample water for soiling  
The stirring mechanism is switched on  
Dose the reagents A and B  
Allow a reaction time of 10 minutes
4. Display the measuring result
5. Drain the measuring chamber
6. Waiting time until the next analysis

**Selecting the display unit**

It is possible to program the unit of the displayed value. The units mg/l and ppm can be selected. All the following inputs and displays will then be displayed in the programmed unit.

|                       |   |
|-----------------------|---|
| >DISPLAYED UNIT ▼▲ ME |   |
| DISPLAY IN mg/l       | * |
| Display in ppm        |   |

- In >BASIC PROGRAM, select  
=> PROGRAM VALUES=> DISPLAYED UNIT
- Select the desired unit
- Press "ENTER" to confirm the selection

---

| >VOLUME         | ▼▲ ME |
|-----------------|-------|
| 500ml bottles   | *     |
| 20/5l container |       |

## Select volume

You can select the volume of the reagent containers. The default method is to link two bottles, each with 500 ml capacity. If necessary, you could use a 20-litre container for reagent A instead and then attach a 5-litre container for reagent B.

- In >BASIC PROGRAM, select
  - => PROGRAM VALUES=> VOLUME
- Select the container being used
- Press "ENTER" to confirm the selection

## Entering further basic program data

For selecting and entering data for these functions, please proceed as described under "Entering basic program data".

### Internal flushing

To ensure that the analysed sample represents the current value, the sampling line must be sufficiently flushed. If the plant has been out of operation for a longer period or in case of long analysis intervals, we recommend you to select a flushing time greater than 60 seconds. Flushing starts by simultaneously opening the inlet and the outlet valve of Testomat 2000® PO4.

#### NOTE

|                             |
|-----------------------------|
| >FLUSH TIMES/INTERVAL ▼▲ ME |
| INTERNAL FLUSH TIME 000s    |
| External flush time 00s     |
| Interval pause 001m         |

#### Duration of the analysis interval

- The analysis interval depends directly on the programmed flushing time. If, e.g., a flushing time of 90 seconds has been set, the actual analysis interval cannot be less than 90 seconds.

- In >BASIC PROGRAM, select  
=> PROGRAM VALUES=> FLUSH TIMES/INTERVAL
- Enter the "FLUSH TIMES/INTERVAL" in seconds (s)
- Press "ENTER" to confirm the entry

#### NOTE

#### Setting the internal flushing time

- For connections longer than 3 m and with an internal hose diameter of 6 mm a minimum internal flushing time of 10 seconds is required to ensure that a valid sample is taken from the sampling line. The required quantity of flush water for one-minute internal flushing is 0.5 litres.

### External flushing

If very short analysis intervals are required, or if a very long (several metres) sampling line or a line with a large diameter is used, an external flush valve should be installed upstream of Testomat 2000® PO4. The external flush valve has to be connected to the "Flush" outlet. If the unit is used for monitoring two measuring points, external flushing prevents incorrect measurements caused by sample mixing. The external flushing time for the valve depends, just as the flushing time for unit flushing does, on the length and diameter of the supply line to Testomat 2000® PO4.

|                             |
|-----------------------------|
| >FLUSH TIMES/INTERVAL ▼▲ ME |
| INTERNAL FLUSH TIME 000s    |
| External flush time 00s     |
| Interval pause 001m         |

- In >BASIC PROGRAM, select  
=> PROGRAM VALUES=> FLUSH TIMES/INTERVAL
- Enter the "FLUSH TIME/EXTERNAL" in seconds (s)
- Press "ENTER" to confirm the entry

## Interval pause

If the analysis is triggered via a timer, the interval between two analyses (plus flushing time) is determined by the interval pause. The shortest interval can be 0 minutes. In this case, analyses are carried out continuously. The longest interval is 255 minutes.

|                             |
|-----------------------------|
| >FLUSH TIMES/INTERVAL ▼▲ ME |
| INTERNAL FLUSH TIME 000s    |
| External flush time 00s     |
| Interval pause 001m         |

- In >BASIC PROGRAM, select
  - => PROGRAM VALUES=> FLUSH TIMES/INTERVAL
- Enter the "INTERVAL PAUSE" in minutes (m)
- Press "ENTER" to confirm the entry

## Limit value monitoring

It is possible to program the limit values on a continuous scale. The limit value range depends on the used indicator type and the programmed unit. Two limit value outputs are available for monitoring. This ensures that two limit values or two measuring points can be monitored. The functions of the allocated relay outputs can be programmed independently of each other.

Monitoring of two limit values

If the unit is used for monitoring two *limit values*, the limit value outputs are permanently allocated to these limit values!

 1 LV1 = Limit value 1       2 LV2 = Limit value 2

Monitoring of two measuring points

If the unit is used for monitoring two *measuring points*, the limit value outputs are permanently allocated to these measuring points!

 1 LV1 = Measuring point 1       2 LV2 = Measuring point 2

If the limit value LV1 has been exceeded, the limit value control display  1 lights up **RED** and the relay output LV1 reacts as programmed in the switch function. If the limit value has not been exceeded, the display lights up GREEN. The same applies for the limit value LV2. The behaviour of switch function 4 is inverse. With switch function 5 both displays illuminate green if the measured value is within the range.

|                           |
|---------------------------|
| >LIMIT VALUES ▼▲ ME       |
| LIMIT VAL. 1: 0,25°dH 00s |
| LIMIT VAL. 2: 0,15°dH     |
|                           |

- In >BASIC PROGRAM, select
  - => PROGRAM VALUES=> LIMIT VALUES
- Enter the values for "LIMIT VALUE 1" or "LIMIT VALUE 2"
- Press "ENTER" to confirm the entry

**Suppression of bad analyses**

| >HYSTERESIS LV1 ▼▲ ME |   |      |
|-----------------------|---|------|
| ANALYSIS (1,2,3)      | 1 | 000l |
|                       |   |      |
|                       |   |      |

| >HYSTERESIS LV2 ▼▲ ME |   |      |
|-----------------------|---|------|
| ANALYSIS (1,2,3)      | 1 | 000l |
|                       |   |      |
|                       |   |      |

**Hysteresis**

The respective limit value output only switches after the first, second or third bad analysis (suppression of the first or the second measured value). This increases the reliability of the analysis evaluation, e.g. after the measuring point has been switched over or if the sampling line has not been flushed sufficiently. The hystereses of the two outputs LV1 and LV2 can be set independently of each other.

With a hysteresis of "2", the next analysis is immediately carried out when the limit value of this analysis has been exceeded for the first time. The respective output is only switched after the limit value of this analysis has been exceeded for a second time. With a hysteresis of "3", the respective output only switches when the limit value of this analysis has been exceeded for a third time. This setting is only reactivated once the value has fallen below the limit value! The behaviour of switch function 4 is inverse.

With switch function 5 hysteresis occurs if limit value LV1 is exceeded and LV2 is not achieved.

(The basic setting for LV1 and LV2 is 1)

- In >BASIC PROGRAM, select
  - => PROGRAM VALUES=> HYSTERESIS LV1 or HYSTERESIS LV2
- Enter the number of analyses
- Press "ENTER" to confirm the entry

**Switch functions of the limit value outputs LV1 and LV2**

Schematic representation of switch

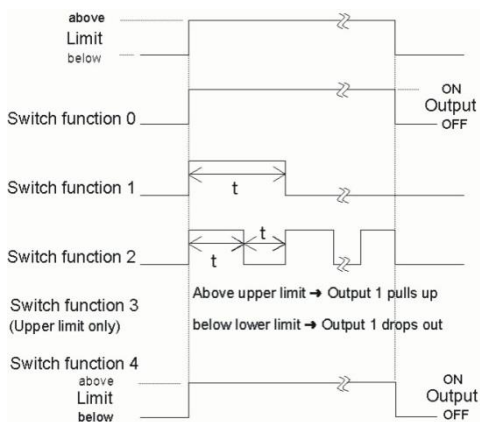

**Switch function 0, duration**

If the limit value LV1 or LV2 has been exceeded, the output relay LV1 or LV2 reacts. If the measured value falls below the limit value LV1 or LV2 without locking, the relevant relay drops out again.

**Switch function 1, impulse**

If the measured value exceeds the limit value LV1 or LV2, the relevant output switches for a settable time (t).

The respective output always remains switched for the set time, irrespective of how long the limit value has been exceeded. A new impulse is only possible once the value has fallen below the limit value!

**Switch function 2, interval**

If the limit value has been exceeded, the respective output switches at intervals with the settable time (t) = impulse or interval. The switching on time and the interval are the same.

### Switch function 3, two-point

If the upper limit value LV1 has been exceeded, the output relay LV1 switches. If the value falls below the lower limit value LV2, the output relay LV1 drops out again. The output relay LV2 switches according to the programmed switch function.

The function 3 is only possible if different values are used for the limit values LV1 and LV2 with just **one** measuring point. For example, for LV1 = 2 mg/l and for LV2 = 1 mg/l.

|                      |         |
|----------------------|---------|
| ->FUNCTION LV1 ▼▲ ME |         |
| DURATION             | *       |
| Duration/inverse     |         |
| Impulse              |         |
| Interval             |         |
| Two point            |         |
| Range LV1-LV2        |         |
| Time:                | 00m:10s |

### Switch function 4, Duration/inverse

If the measured value falls below the limit value LV1 or LV2, the output relay LV1 or LV2 reacts. If the limit value LV1 or LV2 has been exceeded, the relevant relay drops out again.

|                      |         |
|----------------------|---------|
| ->FUNCTION LV2 ▼▲ ME |         |
| DURATION             | *       |
| Duration/inverse     |         |
| Impulse              |         |
| Interval             |         |
| Time:                | 00m:10s |

- In >BASIC PROGRAM, select  
=> PROGRAM VALUES=> FUNCTION LV1 or FUNCTION LV2
- Select the duration, impulse, interval or two-point (only for LV1)
- Enter the time (only for switch function 1 and 2)
- Press "ENTER" to confirm the entry

### Switch function 5, range LV1-LV2

Monitoring the range between limit values LV1 and LV2. If limit value LV1 is exceeded, relay LV1 switches and LED "LV1" illuminates red. If limit value LV2 is not achieved, relay LV2 switches and LED "LV2" lights up red. If the measured value is within the range, both relays are deactivated and both LEDs illuminate green.

If this function has been selected, the setting in the menu item FUNCTION LV2 is ineffective.

### Measuring points

The Testomat 2000® PO4 can be used for monitoring 2 measuring points. Measuring point switch-over can occur either automatically or by triggering a contact (or normally closed) at input IN1. If the external measuring point switch-over has been programmed ("2 measuring points externally"), a respective controller (e.g. timer) has to be connected to IN1 (voltage-free contact required!). The active status of IN1 has to be programmed accordingly.

|                          |  |
|--------------------------|--|
| ->MEASURING POINTS ▼▲ ME |  |
| 1 Measuring Point        |  |
| 2 Meas. Points int.      |  |
| 2 MEAS. POINTS EXT. *    |  |

## Function IN1

An external measuring point switch-over takes place via this input if you have programmed "2 measuring points externally". The active status of IN1 has to be programmed according to the output function of the controller (volt-free contact required!).

- In >BASIC PROGRAM, select
  - => PROGRAM VALUES => MEASURING POINTS => 2 MEAS. POINTS EXT.
- Press "ENTER" to confirm the entry

|                         |
|-------------------------|
| >FUNCTION IN1 ▼▲ ME     |
| NORMALLY OPEN CONTACT * |
| Normally closed contact |
|                         |

- In >BASIC PROGRAM, select
  - => PROGRAM VALUES=> FUNCTION IN1
- Select a normally closed or normally open contact
- Press "ENTER" to confirm the entry

## Water meter

It is necessary to connect a water meter to **input IN2** for quantity-dependent analysis start. Program the corresponding water meter rating.

|                            |
|----------------------------|
| >TYPE OF WATER METER ▼▲ ME |
| 1 LITRE/IMPULSE            |
| 2,5 Litres/Impulse         |
| 5 Litres/Impulse           |
| 10 Litres/Impulse          |
| 100 Litres/Impulse *       |
| 500 Litres/Impulse         |
| 1000 Litres/Impulse        |

- In >BASIC MENU, select
  - => PROGRAM VALUES=> TYPE OF WATER METER
- Select the water meter rating
- Press "ENTER" to confirm the entry

## Alarm/Message

The instrument is equipped with an alarm relay output for signalling faults. The events which mean a fault at the instrument or are intended to trigger a message, can either trigger an alarm "A" (continuous contact) or a message "M" (2-second impulse).

The faults are recorded and stored in the error history if the event has been programmed as an alarm or message. For example, if a low reagent level has not been programmed as an ALARM/MESSAGE, it is not registered in the error history. Up to 20 error messages can be stored. A list of these errors can be opened in the information menu. The information stored per event is the time (day, month, year and hour) and the type of the error.

|                        |       |
|------------------------|-------|
| >ALARM/MESSAGE ▼▲ ME   |       |
| REAGENT LOW LEVEL A    | A/M/- |
| Low water pressure A   | A/M   |
| Ff. optics A           | A/M   |
| Ff. dosing pump A      | A/M   |
| Ff. outlet to drain M  | A/M   |
| Mf. dirtiness A        | A/M/- |
| Power failure 24V M    | A/M   |
| Mf. turbid M           | A/M/- |
| Meas. range exceeded M | A/M/- |
| Maint. int. exceeded M | A/M/- |
| Change pump head 1 A   | A/M   |
| Change pump head 2 A   | A/M   |

A=Alarm,  
M=Message  
- = no action  
Ff.=Function fault

- In >BASIC PROGRAM, select
  - => PROGRAM VALUES=> ALARM/MESSAGE
- Select the type of monitoring A=alarm, M=message or - = no action for the individual menu items
- Press "ENTER" to confirm the respective entry

**NOTE**

**Error messages**

- All error messages are lost after a power failure.
- Certain instrument faults always trigger an alarm or a message (see chapter "Description of the relay outputs")!

**Function AUX**

The AUX relay output can be programmed for the following control functions:

- As a function output for the contact with programmable duration prior to and/or during the analysis, or after an analysis.

For example, it is possible to control the cooling water inlet of an upstream cooler via a solenoid valve. This ensures that the cooling water only flows when required, i.e. when an analysis is being carried out.

|                               |         |
|-------------------------------|---------|
| <b>&gt;FUNCTION AUX</b> ▼▲ ME |         |
| CONTACT BEFORE ANALYS. * *    |         |
| Contact during analysis       |         |
| Contact „Suction“             |         |
| Time:                         | 00m:10s |

- In >BASIC PROGRAM, select  
=> PROGRAM VALUES=> FUNCTION AUX
- Select the program step at which the AUX contact is to be activated
- Under "Time" enter the contact duration in minutes (m) and seconds (s)
- Press "ENTER" to confirm the entry



## Service II

|                      |
|----------------------|
| >SERVICE II ▼▲ ME    |
| CALIBRATION          |
| Reset operating time |
| Maintenance interval |

The service II menu contains various functions for monitoring the operation of the instrument:

Programming of the maintenance interval, operation (reset) internal data/setting, e.g. water quantity and plant monitoring.

### NOTE

#### Use of the Service II menu

The functions in the Service II menu directly influence the operation and monitoring functions of the instrument!

- These tasks should only be carried out by trained and qualified staff.

### Calibration

Entering a calibration factor is not required under normal operating conditions, as the instrument has been calibrated and tested at the factory.

Should the measured value displayed nevertheless deviate from the target value of a measured standard solution, you can adjust the instrument with the calibration factor.

You can calculate the calibration factor as follows:

$$\text{Calibration factor} = \frac{\text{Target value}}{\text{Actual value}}$$

### NOTE

The calibration factor can be between 0.9 and 1.1.

Should the calibration factor vary from 1.0 by more than 10%, send the instrument back to the factory for inspection.

|                         |
|-------------------------|
| >CALIBRATION ▼▲ ME      |
| Calibration factor 1,00 |
|                         |

Select from the menu > BASIC PROGRAM

=> Service II => CALIBRATION

- Enter the desired calibration factor
- Confirm the selection by pressing "ENTER"

### Reset operating time

After replacing a dosing pump or the measuring chamber holder, it is possible to reset the current operating time to 0 hours.

- In >BASIC PROGRAM, select  
=> SERVICE II=> RESET OPERATING TIME

- Select "Reset" to reset the operating time

- Press "ENTER" to confirm the selection

The operating time "000000h" appears on the display

|                      |
|----------------------|
| >SERVICE II ▼▲ ME    |
| Calibration          |
| RESET OPERATING TIME |
| Maintenance interval |

|                       |
|-----------------------|
| >OPERATING TIME ▼▲ ME |
| 000023h               |
| Reset                 |
|                       |

## Maintenance interval

Observance of the maintenance intervals is monitored and displayed by Testomat 2000® PO4. Program the desired maintenance interval in days here. (0 days equals no maintenance interval)

|                      |
|----------------------|
| >SERVICE II ▼▲ ME    |
| Calibration          |
| Reset operating time |
| MAINTENANCE INTERVAL |

|                           |
|---------------------------|
| >MAINTENANCEINTERVAL▼▲ ME |
|                           |
| 000d                      |
|                           |

- In >BASIC PROGRAM, select
  - => SERVICE II=> MAINTENANCE INTERVAL
- Enter the maintenance interval in days (d)
- Press "ENTER" to confirm the entry

## Description of the signal inputs/outputs



**CAUTION**

### Connecting the signal inputs

➤ Only connect the signal inputs "Start", "Stop", "IN1" and "IN2" with *volt-free contacts!*

The connection of external voltages would damage the instrument!

**Start**  
terminals 20,21

| Function   | Test period | Action   |
|--|-------------|--|
| <b>Start</b><br>External analysis start (only normally open) | None        | In the operating mode EXTERNAL, an impulse contact at the input starts an individual analysis, while with permanent contact one analysis after the other is run. |

**Stop**  
terminals 22,23

| Function   | Test period | Action   |
|--|-------------|--|
| <b>Stop</b><br>External analysis stop (e.g. via flow controller or process controller) | None        | There are no analyses while the contact at the input is open or closed |

An active Stop input prevents an analysis start, e.g. via a current interval. This can be necessary if the plant does not supply water. A current analysis is stopped when the input valve is opened (while the measuring chamber is being flushed or filled). The water which has already entered the measuring chamber remains there. If the measuring chamber is already full, the analysis is executed. Manual start has priority over the Stop input, i.e. if the Stop input is active, an analysis can be started manually or a manually started analysis cannot be stopped by the stop signal. In the operating mode "time-controlled", the interval time continues when the Stop input has been activated.

|                           |
|---------------------------|
| >FUNCTION STOP ▼▲ ME      |
| NORMALLY OPEN CONTACT     |
| Normally closed contact * |
|                           |

- In >BASIC PROGRAM, select
  - => PROGRAM VALUES=> FUNCTION STOP
- Select the type of contact
- Press "ENTER" to confirm the selection

## IN1 terminals 24,25

| >MEASURING POINTS ▼▲ ME |
|-------------------------|
| 1 Measuring Point       |
| 2 Meas. Points int.     |
| 2 MEAS. POINTS EXT. *   |

| >FUNCTION IN1 ▼▲ ME       |
|---------------------------|
| NORMALLY OPEN CONTACT     |
| Normally closed contact * |

## IN2 terminals 26,27

## OUT terminals 1, 28,29

| Function  | Test period             | Action   |
|---|-------------------------|--|
| <b>IN1</b><br>external measuring point switch-over<br>(2 measuring points <b>externally</b> programmed) | Fixed,<br>10<br>seconds | As long as the contact at the input is 'open' or 'closed', analyses are carried out from measuring point 2 |

- In >BASIC PROGRAM, select  
=> PROGRAM VALUES=> MEASURING POINTS=> 2 MEAS. POINTS EXT.
- Press "ENTER" to confirm the selection

- In >BASIC PROGRAM, select  
=> PROGRAM VALUES=> FUNCTION IN1
- Select the type of contact
- Press "ENTER" to confirm the selection

| Function                        | Test period | Action   |
|---------------------------------|-------------|--|
| <b>IN2</b><br>Water meter input | None        | Quantity recording for analysis start and plant monitoring |

| Function  | Connection                   | Action                                   |
|---|------------------------------|--|
| <b>OUT</b><br>Programmable current interface<br>0-20 mA or 4-20 mA    | Max. load<br>500 Ohms        |  |
| OR<br>Programmable voltage interface<br>0-10 V or 2-10 V              |                              |  |
| OR<br>Serial interface RS 232   | Serial bus<br>(2-wire cable) | See description of interface card RS 910 |
| Refer to the section entitled "Interfaces" for a detailed description |                              |  |

## Interfaces (optional)

Current interface 0/4-20 mA

### NOTE

#### Current interface load

- The maximum load of 500 Ohms should not be exceeded!  
In case of possible faults and when using very long cables (approx. 20 m), a screened cable should be used, if possible.

## Installing the interface cards SK910/RS910



Avoid static charges during installation!

Personnel responsible for installation must be appropriately trained and qualified!

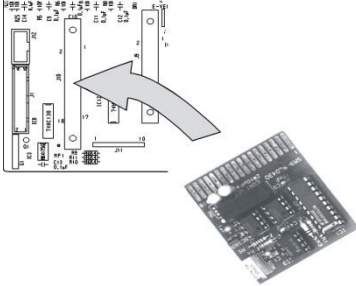

- Switch off the instrument.
- Insert the plug-in circuit board into the left-hand slot with the component side on the left. (Contact no.1 is at the top)
- Switch on Testomat 2000®.
- Program the desired type of current (0/4-20mA) (for SK910).

Example: 1 measuring point, interface 0 - 20 mA

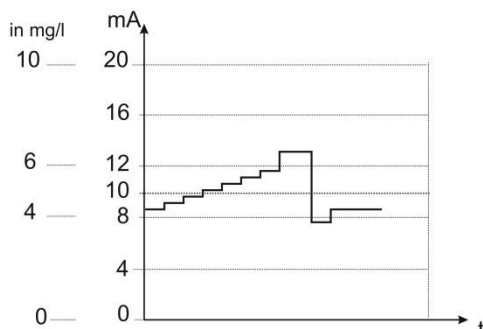

| >INTERFACES ▼▲ ME |   |
|-------------------|---|
| TYPE 0-20mA       | * |
| Type 4-20mA       |   |
| Type RS232        |   |
| Type Data Logger  |   |

| >MEASURING POINTS ▼▲ ME |   |
|-------------------------|---|
| 1 MEASURING POINT       | * |
| 2 Measuring points int. |   |
| 2 Measuring points ext. |   |

- In >BASIC PROGRAM, select  
=> PROGRAM VALUES=> INTERFACES
- Select the desired current range
- Press "ENTER" to confirm the selection

- In >BASIC PROGRAM, select  
=> PROGRAM VALUES=> MEASURING POINTS 1 or 2
- Select the desired configuration
- Press "ENTER" to confirm the selection

## Monitoring a measuring point

A printer can be connected to record the analysis results. The instrument is equipped with a programmable current output for this purpose (optional 0-20 mA or 4-20 mA).

The example on the left displays the current profile in the 0-20 mA range for one measuring point.

## Monitoring of two measuring points

The example on the left displays the current profile for 4 - 20 mA and the use of two measuring points.

Measuring point 1 and measuring point 2 are measured alternatively. The measured value 1 is shown in display line 2 (M1:) and the measured value 2 in line 3 (M2:). The currently analysed measuring point is indicated by an asterisk on the right.

The range of the current interface is divided. The range 4 – 12 mA is available for the measured value from measuring point 1 and range 12 – 20 mA for the measured value from measuring point 2.

- In >BASIC PROGRAM, select  
=> PROGRAM VALUES=> INTERFACES
- Select the desired current range
- Press "ENTER" to confirm the selection

Example: 2 measuring points, interface 4 - 20 mA

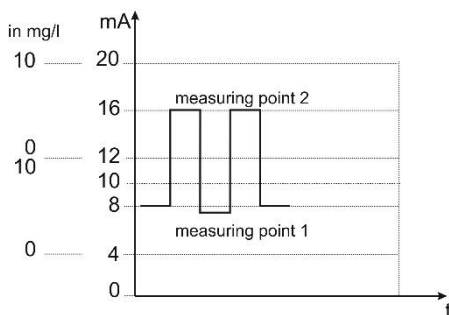

| >INTERFACES ▼▲ ME |   |
|-------------------|---|
| Type 0-20mA       |   |
| TYPE 4-20mA       | * |
| Type RS232        |   |
| Type Data Logger  |   |

| >MEASURING POINTS ▼▲ ME |  |
|-------------------------|--|
| 1 MEASURING POINT       |  |
| 2 Measuring points int. |  |
| 2 Measuring points ext. |  |

- In >BASIC PROGRAM, select
  - => PROGRAM VALUES=> MEASURING POINTS
- Select the desired configuration
- Press "ENTER" to confirm the selection

How is the current calculated for a specific measured value?

### Calculation of output currents

The entire current range (0 – 20 mA or 4 – 20 mA) is available for one measuring point. However, the current range is divided for two measuring points. The value from measuring point 1 is displayed in the lower half (0 – 10 mA or 4 – 12 mA) and the value for measuring point 2 in the upper half (10 – 20 mA or 12 – 20 mA).

1 measuring point  
0 - 20 mA

$$\text{Current} = \frac{\text{Measured value}}{\text{Maximum value}} \times 20 \text{ mA}$$

1 measuring point  
4 - 20 mA

$$\text{Current} = \frac{\text{Measured value}}{\text{Maximum value}} \times 16 \text{ mA} + 4 \text{ mA}$$

2 measuring points  
0 - 20 mA

$$\begin{aligned} \text{Current 1} &= \frac{\text{Measured value 1}}{\text{Maximum value}} \times 10 \text{ mA} \\ \text{Current 2} &= \frac{\text{Measured value 2}}{\text{Maximum value}} \times 10 \text{ mA} + 10 \text{ mA} \end{aligned}$$

2 measuring points  
4 - 20 mA

$$\begin{aligned} \text{Current 1} &= \frac{\text{Measured value 1}}{\text{Maximum value}} \times 8 \text{ mA} + 4 \text{ mA} \\ \text{Current 2} &= \frac{\text{Measured value 2}}{\text{Maximum value}} \times 8 \text{ mA} + 12 \text{ mA} \end{aligned}$$

Measuring range exceeded (e.g. >10 mg/l)

The current is set to 20 mA.

Measured value = the value shown on the display in the selected unit  
Maximum value = the end value of the applied reagent (10 mg/l)

### Serial interface RS232

Testomat 2000® PO4 can also be connected to a log printer via the serial interface RS232 to enable the printout of measuring results and error messages. Analyses can then be continuously logged. This option is only possible in connection with the RS-232 interface card for log printer, RS910 (Art. no. 270310).

| >INTERFACES ▼▲ ME |
|-------------------|
| Type 0-20mA       |
| Type 4-20mA       |
| TYPE RS232 *      |
| Type Data Logger  |

- In >BASIC PROGRAM, select
  - => PROGRAM VALUES=> INTERFACES
- Select the desired interface
- Press "ENTER" to confirm the selection

## SD card data logger

With the SD card data logger (article number 100490), the measurements of the Testomat 2000® can be logged continuously.

To operate the data logger, please proceed as follows:

| >INTERFACES ▼▲ ME |
|-------------------|
| Type 0-20mA       |
| Type 4-20mA       |
| Type RS232        |
| Type Data logger  |

- In >BASIC PROGRAM, select
  - => PROGRAM VALUES=> INTERFACES
- Select TYPE DATA LOGGER
- Press "ENTER" to confirm the selection

## Description of the relay outputs

All relay outputs are neutral contacts. This ensures that all connection options are available. The switching of mains voltage and external voltage, and the direct switching of inputs, e.g. a process controller, can be realised.

**Flush valve**  
terminals 1, 2

### Flushing (external flush valve)

Immediately before each analysis the external flush valve is opened for the programmed period allowing the line up to Testomat 2000® PO4 to fill with measuring water. Please ensure that the programmed flush time is sufficient.

Please refer to "Entering further basic program data" → "External flush" for programming details

### LV1 and LV2 limit value outputs

Two volt-free relay contacts are available to signal that a limit value has been exceeded. The limit values, the hysteresis and the switch function can be freely programmed for both contacts.

**Limit value 1**  
terminals 3, 4, 5

| Function   | Contact                                 | Action  |
|--|---|---|
| <b>LV1</b><br>Relay switches when the limit value is exceeded at:<br>Limit value 1 or<br>measuring point 1 | Volt-free<br>change-<br>over<br>contact | Programmable:<br>- Continuous contact<br>- Impulse (1-99 seconds/minutes)<br>- Interval (1-99 seconds/minutes)<br>- Two-step controller (only for one measuring point)<br>- Hysteresis (limit value is exceeded once, twice, three times) |

**Limit value 2**  
terminals 6, 7, 8

| Function   | Contact                       | Action  |
|--|-------------------------------|---|
| <b>LV2</b><br>Relay switches when the limit value is exceeded at:<br>Limit value 2 or<br>measuring point 2 | Volt-free change-over contact | Programmable:<br>- Continuous contact<br>- Impulse (1-99 seconds/minutes)<br>- Interval (1-99 seconds/minutes)<br>- Hysteresis (limit value is exceeded once, twice, three times) |

Please refer to the section entitled "Switch functions of the limit value outputs LV1 und LV2" for more details and programming!

### Measuring points 1 or 2 (measuring point switch-over)

**M. point switch-over**  
terminals 9, 10, 11

If the instrument is used for monitoring two measuring points, the solenoid valves (individual valves or one 3/2-way control valve) of the corresponding sampling line have to be connected to this output. The terminals are strictly allocated to the measuring points.

Terminal 9 = Measuring point 1 , Terminal 10 = Measuring point 2

| >MEASURING POINTS ▼▲ ME |
|-------------------------|
| 1 Measuring Point       |
| 2 MEAS. POINTS INT. *   |
| 2 Meas. Points ext.     |

- In >BASIC PROGRAM, select  
=> PROGRAM VALUES=> MEASURING POINTS
- Select "2 Measuring points"
- Press "ENTER" to confirm the selection

### AUX (programmable function output)

**AUX**  
terminals 12, 13

The functioning of this volt-free relay output is programmable:

1. for reporting a current analysis and/or
2. for contact prior to an analysis, e.g. to operate with a cooler or
3. to control a feed pump for sampling

| >FUNCTION AUX ▼▲ ME         |
|-----------------------------|
| CONTACT BEFORE ANALYSIS * * |
| Contact during analysis     |
| Contact „Suction“           |
| Time: 00m:10s               |

- In >BASIC PROGRAM, select  
=> PROGRAM VALUES=> FUNCTION AUX
- Select the program step at which the AUX contact is to be activated
- Under "Time" enter the contact duration in minutes (m) and seconds (s)
- Press "ENTER" to confirm the entry



**Alarm**

terminals 14, 15, 16

The following faults activate the "Alarm" output and are displayed:

**Always** fault message for:

Power failure  
 Low water level  
 Function fault optics  
 Measuring fault analysis  
 Function fault dosing pump  
 Function fault drain outlet  
 Function fault failure 24V

**Programmable** fault messages for:

Low indicator level  
 Function fault dosing error  
 Function fault soiling  
 Measuring fault turbid  
 Plant monitoring  
 Measuring range exceeded  
 Maintenance exceeded

**Alarm (fault message output)**

The "Alarm" output is a volt-free change-over relay contact. During trouble-free operation, the contact between the terminals 15 – 16 is closed and the one between terminals 14 – 16 is open. In case of a voltage breakdown, the contact between the terminals 14 – 16 is closed and the one between terminals 15 – 16 is open.

The instrument is equipped with a range of monitoring functions. You can define the individual statuses as a fault and program the corresponding message either as a continuous contact (A) or as a message impulse (M).

Functions/Behaviour of the "Alarm" output:

- With a continuous contact, the "Alarm" output remains activated (terminals 14 – 16 closed) as long as the fault persists.
- With a message impulse, the output is switched 'on' for 2 seconds and then switched 'off' for 5 seconds.
- If several faults with differently programmed messages are signalled simultaneously, the output is switched to continuous contact.
- The red LED "Alarm" and the text on the display indicate a fault.
- The fault message signal at the "Alarm" output is deleted by confirming the fault via the "Horn" key.
- The error message can only be deleted if the fault has been eliminated.
- Exception: The maintenance has been exceeded. This message is confirmed in the M menu, see below (Maintenance).
- Each new fault is entered into the error history (also see "i menu").
- There is **no** additional alarm via the fault message output when the limit value is exceeded!

The error messages are described under "Error messages/Troubleshooting"

**Maintenance**

terminals 17, 18, 19

**Activation** of the maintenance output for:

Low reagent level  
 Function fault dosing error  
 Function fault soiling  
 Maintenance date reached

**Maintenance (output for maintenance message)**

The "Maintenance" output is a volt-free change-over contact. During trouble-free operation without a programmed maintenance interval, the contact between the terminals 17 – 19 is closed and the one between terminals 18 – 19 is open.

The instrument is equipped with a range of monitoring functions and a programmable maintenance interval. The respective maintenance message is always a continuous contact.

A maintenance request is displayed via the yellow "Maintenance" LED. The maintenance display can only be deleted once the status has been corrected or after the maintenance request has been confirmed.

Please refer to the section "Password protection and basic programming" for further programming details.

# Information menu "i"

In the information menu, it is possible to request active settings and statuses of the instrument, the error history, the date for the next maintenance and the customer service address.

## Call (1)

Use the  key to open the information menu "i".

Request options: Customer service, operating values, program values, error history, maintenance

### Customer service (2)

Display of the customer service address or, e.g., a service hotline.  
You can freely program these lines in the basic program (password protected).

### Operating values (3)

Display of current values.

### Program values (4)

Use the arrow buttons to call the menu item "Program values". Press "ENTER" to open the list of set values. The current setting of a parameter can be requested via "ENTER",

An asterisk indicates the selected functions. (There are no active lines)

### Error history (5)

Use the "i" and "ENTER" keys to open the error history. The error history is a list of errors or statuses which have occurred during operation. The list is deleted after a power failure and a new list is started.

If no errors have occurred since start-up, the last switch-on time of the unit is displayed, e.g.:

**POWER FAILURE**  
from 16.06.09 06:56  
to 16.06.09 07:09

### Maintenance (6)

Display of the next maintenance date and the programmed maintenance interval. It is possible to set the maintenance interval in the basic program (password protected).  
Refer to the section entitled "Maintenance" for further details on maintenance intervals.

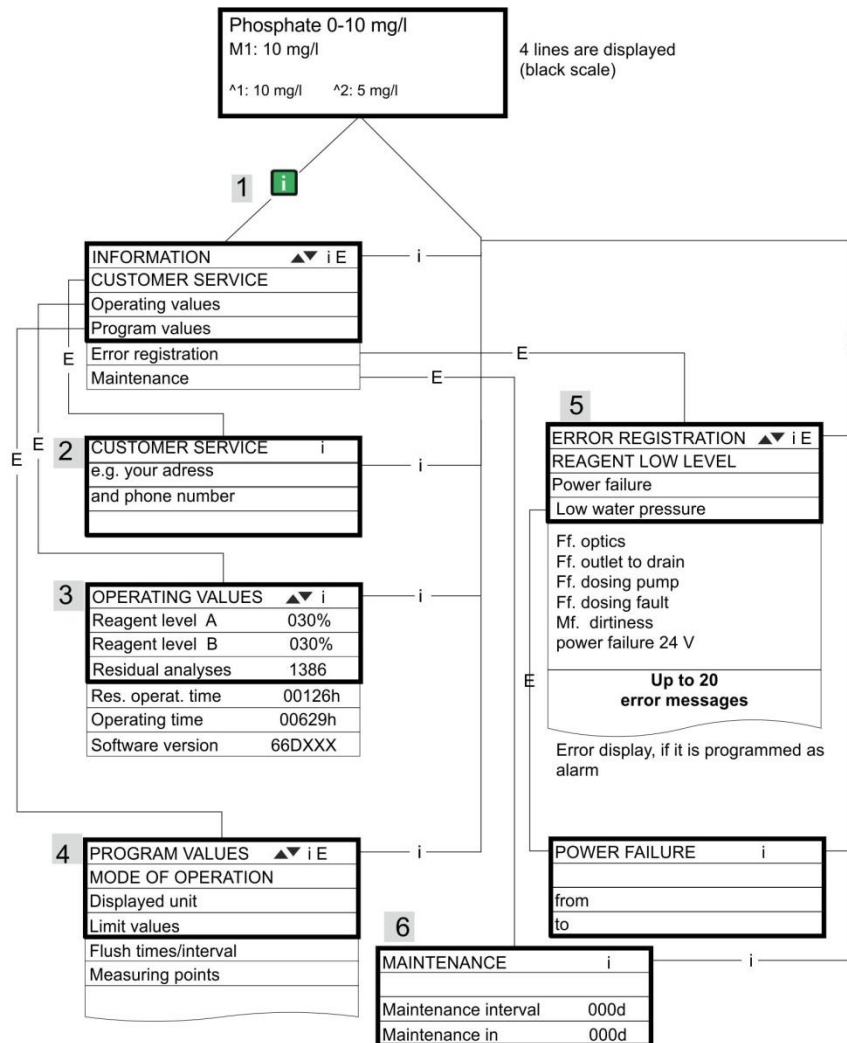

Please refer to the section "Password protection and basic programming" for further programming and setting details for the individual menu items

**Service I (2)**

**Input reagent (3)**

Enter the new filling levels after each refill or reagent bottle change. Once you have selected the menu item for entering the filling level "Reagent X Filling (0 - 100%)" via the "ENTER" key, the value is preset to 100%. If a full bottle has been connected, confirm this value via the "ENTER" key. If the filling of the bottle differs, enter the corresponding value.

**Manual operation (4)**

After confirming the information message (4) via the "ENTER" key, it is possible to select and activate the desired function by using the arrow keys and pressing the "ENTER" key. These functions are used for checking the functions and for commissioning.

**Flush (5)**

Start the flushing of the sampling tube through the internal valve by pressing "ENTER". When "ENTER" is pressed again, this function is terminated.

**Flush chamber (6)**

Press the "ENTER" key to flush the measuring chamber once.

**Drain chamber (7)**

Press the "ENTER" key to open the outlet valve in order to drain the water from the measuring chamber. Press the "ENTER" key again to cancel this function.

**Fill chamber (8)**

Press the "ENTER" key to fill the measuring chamber.

# Program menu "M"

**Call: (1)**

Use the **M** key to open the program menu "M".

It is possible to call up all the functions without password protection except for the basic program.

Programming of: reagents, manual mode, flushing, flush chamber, drain chamber, fill chamber, self-test, confirm maintenance, diagnosis, date, time, basic program with password

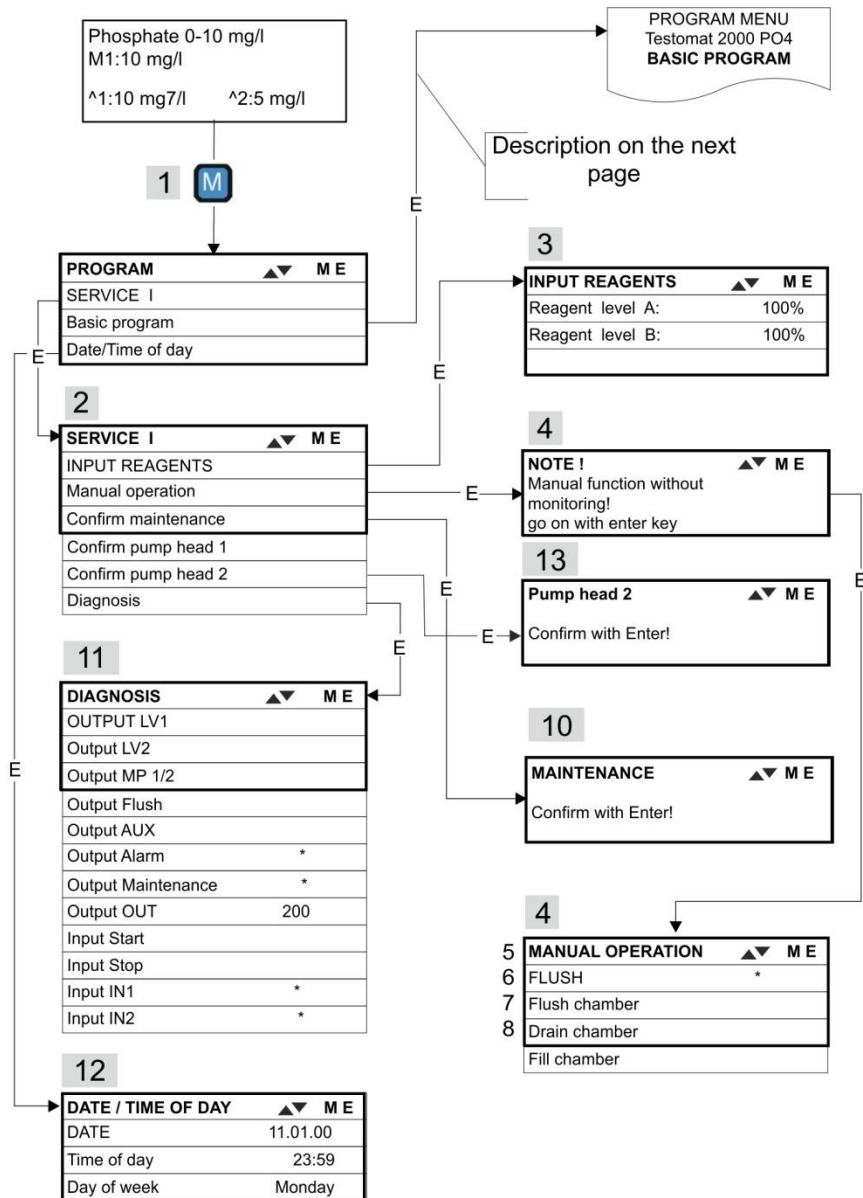

**NOTE**

**Availability of functions**

- All manual functions can only be selected during an analysis pause. Analyses are not carried out during manual operation. All signal inputs and outputs are locked.

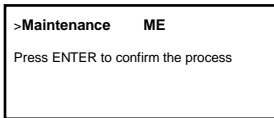

### Confirm maintenance (10)

After maintenance has been carried out, confirm it by pressing the "ENTER" key and exit this item via the "M" key. The maintenance interval is restarted.

Confirm a maintenance request once the maintenance interval has expired in the M menu. The displayed message is deleted and the "maintenance" output reset.

Refer to the section entitled "Maintenance" for further details on maintenance intervals.

|                    |     |
|--------------------|-----|
| >DIAGNOSIS ▼▲ ME   |     |
| OUTPUT LV1         |     |
| Output LV2         |     |
| Output MP. 1/2     |     |
| Output flush       |     |
| Output AUX         |     |
| Output Alarm       | *   |
| Output maintenance | *   |
| Output OUT         | 200 |
| Input Start        |     |
| Input Stop         |     |
| Input IN1          | *   |
| Input IN2          | *   |

### Diagnosis (11)

It is possible to request a list of current statuses of the signal inputs and outputs. Active statuses are marked with an \*. (see "Structure of the basic program").

The current interface can be checked under the "OUT output". Press the "ENTER" key to toggle between minimum and maximum current. Change-over occurs between 000 and 200 at 0-20 mA and between 040 and 200 at 4-20mA!

### Time/Date (12)

Set the time and date by selecting and activating the desired function via the arrow keys and the "ENTER" key. Subsequently press the "M" key again to save the setting and to return to the display function.

Refer to "Functions of the operating and display elements" → "Operating system" for more details.

### Call the factory default setting:

Press the "M" and "i" key and switch on Testomat 2000® PO4.

**Caution:** All previously entered data is overwritten!

The values and settings of the basic default setting are described in the "structure of the basic program".

### Confirm pump head change (13)

After pump head change has been carried out, confirm it by pressing the „Enter” key and exit this item via the „M” key.

The change interval for the pump head is resetted.

Confirm the change request in the „M” menu once the change interval has expired. The displayed message is deleted and the maintenance output reset.

### Basic program

This menu item can only be accessed after entering the password!

After entering the password and confirming it via the "ENTER" key, it is possible to carry out basic programming of the instrument and to select various service functions (e.g. calibration).

In the basic program, the following abbreviations are used in the respective menu items:

s = seconds; m = minutes; h = hours; T = days; l = litre

## Structure of the basic program

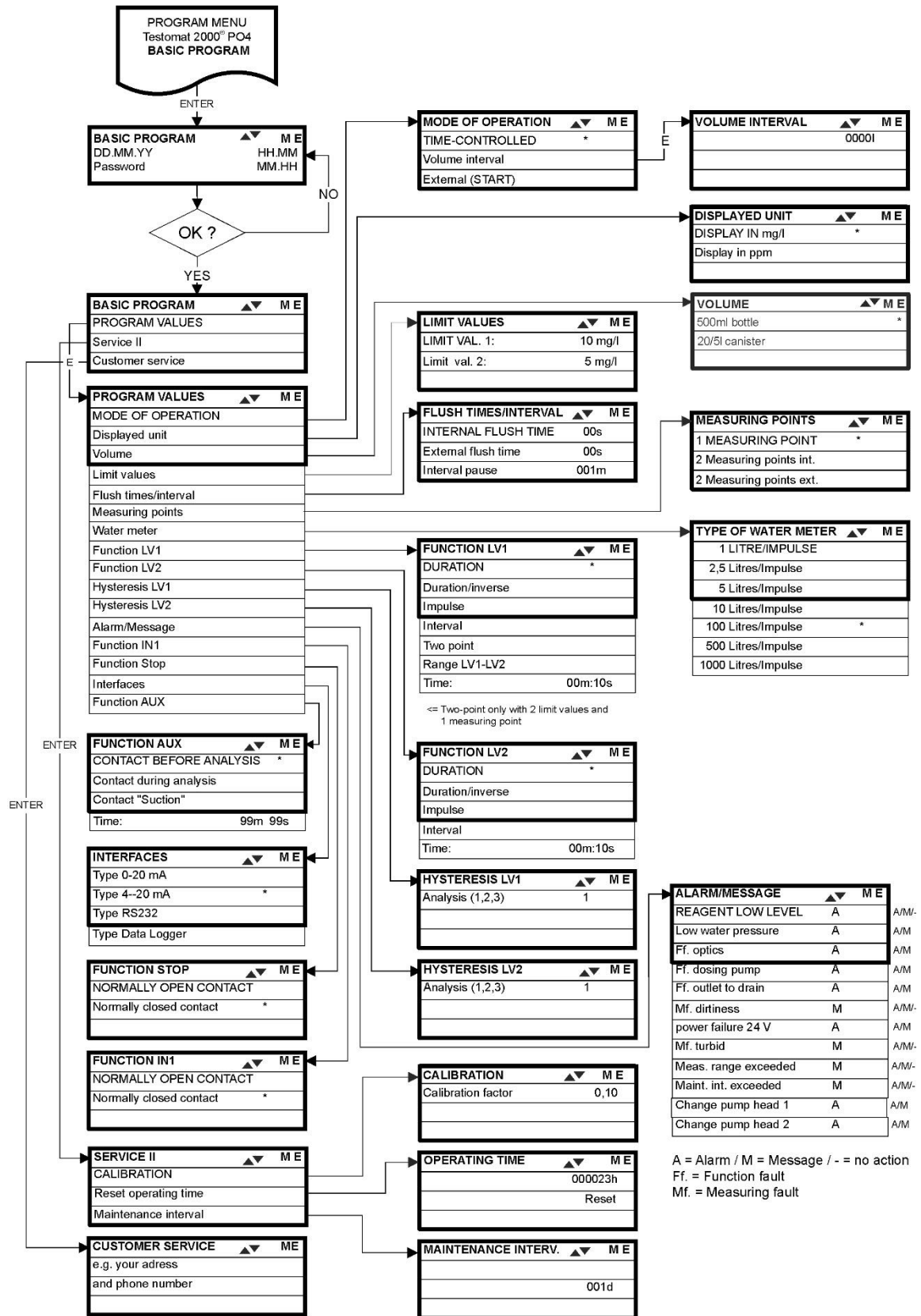

Call the basic factory program by simultaneously pressing and holding down the "M" and "i" keys while switching on the instrument. CAUTION, the last set of programming will be erased!

## Error messages/Troubleshooting

| Displayed message (flashes at selected display)                     | Instrument result functions  | Possible causes  | Remedies  |
|---|--|--|---|
| Ff. POWER FAILURE 24 V<br>➤ CANCEL WITH HORN KEY                    | - After programming:<br>Continuous alarm or message impulses<br>- Standby  | - Internal power failure of the 24 V supply  | ➤ Replace fuse F4 or F8 (The control lamp "Power" of the dosing pump should illuminate)   |
| Ff. DOSING PUMP<br>➤ CANCEL WITH HORN KEY                           | - After programming:<br>Continuous alarm or message impulses<br>- Standby  | - Dosing pump is defective<br>- No dosing message from the dosing pump   | ➤ Replace dosing pump<br>➤ Check cable to the dosing pump for correct connection  |
| Mf. TURBID<br>➤ CANCEL WITH HORN KEY                                | - After programming:<br>Continuous alarm or message impulses or no message<br>- Continue measurements                                      | - The water is turbid / soiled   |   |
| MEASURING RANGE EXCEEDED<br>➤ CANCEL WITH HORN KEY                  | - After programming:<br>Continuous alarm or message impulses or no message<br>- Continue measurements                                      | - The measuring range has been exceeded  |   |
| LOW WATER LEVEL<br>➤ CANCEL WITH HORN KEY                           | - After programming:<br>Continuous alarm or message impulses<br>- Standby  | - No water input although LED "IN" lamp illuminates<br>- Inlet pressure too low<br>- Overflow detection does not react | ➤ Check water inlet<br>➤ Connector at the inlet valve oxidised<br>➤ Clean filter strainer<br>➤ Replace valve block<br>Extract pressure controller valve body<br>➤ Replace fuse F6 |
| Ff. OUTLET TO DRAIN<br>➤ CANCEL WITH HORN KEY                       | - After programming:<br>Continuous alarm or message impulses<br>- Standby  | - Water remains in the measuring chamber although LED "OUT" illuminates  | ➤ Check water outlet<br>➤ Connector at the outlet valve oxidised<br>➤ Replace valve block   |
| LOW REAGENT LEVEL<br>➤ CANCEL WITH HORN KEY                         | - After programming:<br>Continuous alarm or message impulses or no message<br>- LED and output "maintenance" on<br>- Continue measurements | - Minimum reagent quantity not reached   | ➤ Check reagent level and, if necessary, refill (enter the filling quantity!)   |
| Mf. SOILING<br>➤ CANCEL WITH HORN KEY                               | - After programming:<br>Continuous alarm or message impulses or no message LED and output "maintenance" on<br>- Continue measurements      | - Sight-glass windows are soiled   | ➤ Clean sight-glass windows   |
| Ff. OPTICS<br>➤ CANCEL WITH HORN KEY                                | - After programming:<br>Continuous alarm or message impulses<br>- Standby  | - Plug-in circuit board defective<br>- Error at the optical component (transmitter or receiver defective)              | ➤ Replace plug-in circuit board<br>➤ Replace the measuring chamber holder   |
| MAINTENANCE INTERVAL EXCEEDED BY XXX DAYS<br>➤ CANCEL WITH HORN KEY | - After programming:<br>Continuous alarm or message impulses or no message<br>- LED and output "maintenance" on<br>- Continue measurements | - Programmed maintenance date reached or exceeded  | ➤ Carry out maintenance and subsequently cancel or confirm  |
| CHANGE PUMP HEAD 1<br>CHANGE PUMP HEAD 2                            | - After programming:<br>Continuous alarm or message impulses or no message<br>- LED and output "maintenance" on<br>- Continue measurements | - end of lifetime  | ➤ Change pump head and confirm  |

Abbreviations: Ff.: = function fault, Mf. = Measuring fault

## Further information

| Error  | Possible causes   | Remedies   |
|--|---|--|
| Current interface functions incorrectly                              | - Incorrect measured value at the output or no power supplied   | <ul style="list-style-type: none"> <li>➤ Replace fuse F7</li> <li>➤ Replace the interface circuit board</li> </ul>   |
| Unit is not functioning, even though it is switched on<br>No display | <ul style="list-style-type: none"> <li>- Fuse F9, F5 or F2 (240 V: F1) defective</li> <li>- Power switch defective</li> <li>- Ribbon cable at display circuit board or base circuit board is loose</li> <li>- Error at display circuit board or base circuit board</li> </ul> | <ul style="list-style-type: none"> <li>➤ Replace fuses</li> <li>➤ Replace power switch</li> <li>➤ Reconnect ribbon cable</li> <li>➤ Replace display or base circuit board</li> </ul> |

### Tripping of a protective circuit

After a protective circuit (fuse) has been tripped, attempt to eliminate the cause of malfunctioning (e.g. replace a defective valve) before reactivating the protective circuit. Frequent triggering is always due to power overload which, in certain circumstances, may also damage to the instrument.

### Malfunctioning/Repairing a defective instrument

The repair of a defective instrument – irrespective of the warranty period – is only possible when the instrument is dismantled and returned to us with a description of the error. Furthermore, please inform us of the measured medium. Before you return the instrument for repair work, remove the bottles and ensure that the measuring chamber has been flushed out and is empty.

# Maintenance

## NOTE

### Required maintenance measures

- Regular maintenance is necessary to ensure trouble-free operation of the instrument!

Please regularly carry out the maintenance work described in the following section when

- the programmed maintenance date has been reached (display "maintenance interval exceeded")
- the instrument displays the following error messages: "Mf. dirtiness" or "Low Reagent low level"
- the last maintenance was carried out max. 6 months ago

## CAUTION

### Cleaning measures

- Never use organic solvents to clean the measuring chamber or other plastic parts!
- Please observe the safety regulations when handling cleaning agents!
- If the measuring range of the instrument is exceeded over a longer period of time, a coloured film may form on the sight-glass windows. Use isopropanol to remove this sticky film.



①

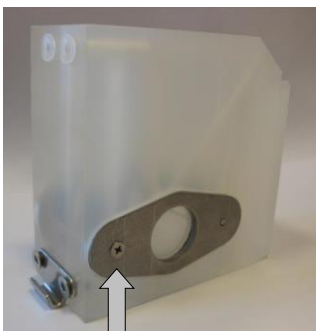

②

## Description of maintenance work

The maintenance manual Testomat 2000®/Testomat ECO® contains a detailed description of maintenance work. The measures described here provide a brief overview.

### Cleaning the measuring chamber and sight-glass windows

- Switch off the instrument or press the "STANDBY" key . If required, remove any water from the measuring chamber:

**M** → SERVICE I → MANUAL OPERATION → Drain chamber

- Close the manually-operated valve of the branch line to Testomat 2000® PO4.
- Unhook the toggle type fastener ①, tip the measuring chamber upwards and remove it.
- Release both sight-glass window holders ②, remove and clean the sight-glass windows.
- Use isopropanol to clean off the film on the sight-glass windows. If the instrument has been used with hard water for a longer period of time (measuring range exceeded!), a hard-to-remove film may have formed on the sight-glass windows. In this case, clean the sight-glass windows as described below for cleaning the measuring chamber.



- The measuring chamber can be cleaned with a cleaning agent suitable for decalcification and rust removal. Flush the measuring chamber thoroughly after cleaning.
- After cleaning, re-insert the sight-glass windows and secure them with the sight-glass window holders b. (Do not forget the flat seals, making sure they are fitting correctly in the groove).
- Re-insert the measuring chamber and use the toggle type fastener to secure it.

**ATTENTION**

---

### Removal and installation of the sight glass windows

Ensure tension-free mounting of the sight glass windows. Tighten the screws equally alternating both sides. Otherwise, the sight glass windows may break.

---

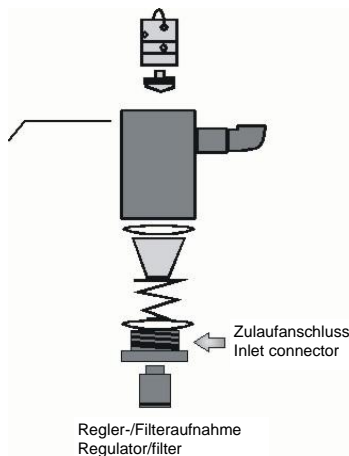

### Cleaning the filter housing

- Close the manually-operated valve of the branch line to Testomat 2000® PO4.
- Depressurise the lines of Testomat 2000® PO4 via the "Flush" function:
  - SERVICE → MANUAL OPERATION → Flush chamber
- Switch of the instrument and loosen the hose connections at the filter housing.
- Unscrew the inlet connection using an open ended spanner (size 22) and remove the seal, spring and filter.
- Remove the retaining pin and extract the flow controller, subsequently remove the flow controller valve body.
- Clean the filter housing with water or isopropanolol; then reassemble the unit.
- If required, replace the seals.
- Insert the filter strainer with the cone facing downwards!
- Re-attach the hose connections at the filter housing.

---

### Important maintenance information

Water leakage at sealed points can damage parts of the instrument! Please check the instrument for leaks prior to the first analysis.

- Switch the instrument to STANDBY
  - Manually fill the measuring chamber
  - Manually dose the indicator ("Manual" key)
  - Check the connections and seals for leaks
- 

**CAUTION**

### Service instructions

The surface of the instrument has not been treated. Therefore, soiling caused by indicators, oil or grease should be avoided. However, if the

housing becomes soiled, please clean the surface with isopropanol (never use other solvents).

## Maintenance message pump head

During operation, the effective run time of the pump head is counted. When a run time of 150 hours is reached, the maintenance message for the pump head appears. During normal operation (analysis interval, every 15 min), this run time is achieved after approximately 2.5 years or 81,000 analyses.

|                     |
|---------------------|
| >SERVICE I ▼▲ ME    |
| Input Reagents      |
| Manual operation    |
| Confirm maintenance |
| Confirm pump head 1 |
| Confirm pump head 2 |
| Diagnosis           |

➤ To confirm the information message, please select the following in the program menu:

>Service I -> Confirm pump head

➤ Now press ENTER.

The maintenance message of the pump head has now been reset.

### NOTE

### Maintenance interval for the pump head

We recommend replacing the pump head after 2 years as the performance of the pump head can decrease due to wear-and-tear. Always replace the pump head if the maintenance message "Replace pump head" is displayed.

## Replacing the pump head

To replace the pump head, proceed as described below:

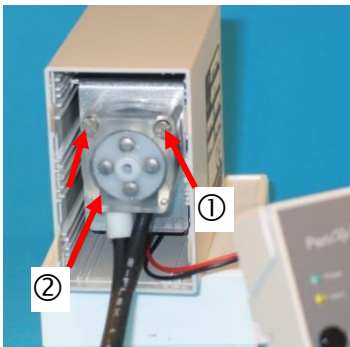

- Remove the transparent cover.
- Open the housing with a suitable screwdriver (push down the snap-on fastening on both sides).
- Carefully pull-out the pump head with a drive mounting bracket.
- Loosen both screws ① at the pump head.
- Pull the pump head from the motor shaft.
- Place the new pump head on the shaft. The short hose with the stopper ② must be on the left-hand side.

### NOTE



### Anti-twist guard

Please observe the anti-twist guard on the motor shaft and the pump head during installation! The drill hole and the shaft each have a flat surface and only fit together in one position. Carefully turn the pump head into the correct position until the snap-in noses snap into the provided drill holes in the housing.



- Re-assemble the pump in reverse order. Make sure that wires or hoses are not trapped.

Do not place the drive mounting bracket on the top slide-in rail ③, as this could cause the pump head to come into contact with the circuit board.

## Testomat 2000® PO4 spare parts and accessories

| Art. no.                         | Pressure controller   |
|----------------------------------|---|
| 40125                            | Controller / Filter receiver, complete                          |
| 40120                            | Controller / Filter receiver                                    |
| 40129                            | Controller plug T2000, complete                                 |
| 11225                            | Flow controller valve body                                      |
| 11270                            | Retaining pin 3x50 / 135 grad                                   |
| 11217                            | Inlet filter  |
| 11218                            | Spring for inlet filter   |
| 40121                            | Inlet connector   |
| 40122                            | PVC drainage connection   |
| Measuring chamber                |   |
| 40378                            | Measuring chamber T2000 compl. with short measuring section, SP |
| 33777                            | Flat seal   |
| 40244                            | Sight-glass 30 x 3 for short measuring section                  |
| 40176                            | Sight-glass holder  |
| 33253                            | Bolt M3x40  |
| 40032                            | Latch fastener TL-17-201-52                                     |
| 11210                            | Plug for measuring chamber                                      |
| Measuring chamber holder         |   |
| 40407                            | Measuring chamber holder DUO                                    |
| 40050                            | Magnetic stirrer  |
| 40583                            | Straight screw-in connection 6-1/8 processed                    |
| 40349                            | Solenoid valve, 2/2-way, PEEK                                   |
| Dosing pump PERIClip             |   |
| 270430                           | Dosing pump PeriClip, complete                                  |
| 40362                            | Pump head PeriClip SP   |
| Bottle connection/Suction device |   |
| 37644                            | Screw cap with bottle insert for 500 ml bottle                  |
| 40535                            | Suction lance for 20-litre container                            |
| 40536                            | Suction lance for 5-litre container                             |

| Art. no.  | Instrument spare parts                                   |
|---|--|
| 31582   | Fuse M4A   |
| 40294   | Base circuit board T2000 complete 230 V                  |
| 40092   | Control circuit board T2000 complete                     |
| 40384   | Plug-in circuit board driver/receiver SE-T2000 PO4       |
| 40190   | Cable gland 5-7  |
| 40191   | Cable gland 7-10   |
| 31713   | Ribbon cable 10 pole with EMI filter clamp               |
| 40096   | Ribbon cable 26 pole with EMI filter clamp               |
| 40060   | Cable loom 2V complete (for valves)                      |
| 40062   | Cable loom 2P complete (for max. 2 dosing pumps)         |
| 40200   | Cable loom complete with mains switch and cap            |
| 31596   | Fuse T0.08A  |
| 31585   | Fuse T0.315A   |
| 31595   | Fuse T0.1A   |
| 31622   | Fuse T0.16A  |
| 31592   | Fuse T1.0A   |
| Piping  |  |
| 40581   | Straight screw-in connection 6-1/8 PVDF                  |
| 40581   | Straight screw-in connection 6-1/4 PVDF                  |
| 40582   | Straight screw-in connection 10-3/8 PVDF                 |
| 40583   | Straight screw-in connection 6-1/8 processed             |
| 40584   | Adjustment angle 6-A6 PVDF                               |
| 40585   | T screw connection 10 PVDF                               |
| 40586   | Reduction screw connection A10-6                         |
| Spare parts requirements for 2 - 3 years of operation |  |
| 40358   | Sight-glass with seal for short measuring section        |
| 11217   | Inlet filter   |
| 40124   | Gasket set T2000 (according to maintenance requirements) |
| 31585   | Fuse T0.315A   |
| 31592   | Fuse T1.0A   |

## Accessories

| Type of Reagent                  | Quantity  | Art. no.: |
|----------------------------------|-----------|-----------|
| Reagent set PO4 2100 A + B       | 500 ml    | 156264    |
| Testomat 2000 Reagent PO4 2100 A | 20 litres | 156281    |
| Testomat 2000 Reagent PO4 2100 B | 5 litres  | 156282    |

Please refer to our delivery programme for an up-to-date overview of available accessories.

| Art. no. | Description                                   |
|----------|---|
| 040123   | Retrofit kit for water inlet *)               |
| 270305   | Current interface card 0/4 - 20 mA, SK 910    |
| 270310   | RS-232 interface card for log printer, RS 910 |
| 270315   | Voltage interface card 0/2 - 10 V, UK 910     |
| 100490   | SD-Card Data Logger for Testomat 2000         |
| 270410   | Booster pump                                  |
| 270337   | Maintenance case T2000 Heyl                   |
| 270354   | Service set Testomat PO4                      |

### **\*) Retrofit kit for water inlet (Art. no. 040123)**

If fabric-reinforced pressure hoses (e.g. for existing installations) are used, please replace the plug connector at the controller and filter housing with a plug for the quick-release coupling (not included).

## Technical data

|                       |  |   |
|-----------------------|--|---|
| Power supply:         | 230 VAC, 115 VAC or 24 VAC $\pm$ 10%, 50 - 60 Hz<br>Instrument fuse 230 V: T0,1 A<br>Instrument fuse 115 V: T0,2 A<br>Instrument fuse 24 V: T1,0 A |  |
| Power consumption:    | max. 30 VA, without external load  |   |
| Protection class:     | I  |   |
| Degree of protection: | IP 65  |   |
| Conformity:           | EN 61000-6-2, EN 61000-6-4, EN 61010-1<br>BS EN 61000-6-4+A1, BS EN 61000-6-2, BS EN 61010-1+A1  |   |
| Ambient temperature:  | 15 – 25 °C   |   |
| Measuring range:      | See section "Performance specifications"   |   |
| Current interface:    | 0/4 - 20 mA, max. load 500 Ohms  |   |
| Log printer:          | See section "Accessories"  |   |
| Dimensions:           | W x H x D = 380 x 480 x 280 mm   |   |
| Weight:               | Approx. 9.5 kg   |   |
| Other:                | The instrument is non-volatile   |   |

|                         |  |
|-------------------------|--|
| <b>Water connection</b> |  |
| Operating pressure:     | 1 to 8 bar / $1 \times 10^5$ to $8 \times 10^5$ Pa<br><b>or</b><br>0.3* to 1 bar / $0.3 \times 10^5$ to $1 \times 10^5$ Pa<br>( Remove flow controller valve body 11225! ) |
| Water inlet:            | Opaque pressure hose with external diameter 6/4x1 mm   |
| Water outlet:           | Hose with internal diameter 12 mm  |
| Water temperature:      | 5 to 30 °C   |

\* When using Testomat 2000® at a pre-pressure of 0.3 bar, it must be ensured that the flow rate through the measuring chamber is at least 400 ml/min.

**We reserve the right to make technical changes without notice in the interest of constantly improving our products!**  
Our manuals are updated regularly. If you have an older version (see version at the back of the manual) you will find the current manual on our website [www.heylandanalysis.de](http://www.heylandanalysis.de) on the download page.

## Conformity Declaration



EC Conformity Declaration



for the following product

**Testomat 2000® PO4**  
**Process Photometer for Phosphate 0 – 10 mg/l**

We hereby confirm that the above product conforms to the principal health and safety regulations laid down in the EC Directives 2014/30/EU and 2014/35/EU.

This declaration applies to all units produced in accordance with the attached manufacturing documents which are a constituent part of this declaration.

**The product was assessed with reference to the following standards:**



**EN 61000-6-4:** Electromagnetic compatibility, Generic emission standard

**EN 61000-6-2:** Electromagnetic compatibility, Generic immunity standard

**EN 61010-1:** Safety requirements for electrical equipment for measurement, control and laboratory use



**BS EN 61000-6-4+A1** Electromagnetic compatibility (EMC). Generic standards. Emission standard for industrial environments

**BS EN 61000-6-2** Electromagnetic compatibility (EMC). Generic standards. Immunity standard for industrial environments

**BS EN 61010-1+A1** Safety requirements for electrical equipment for measurement, control, and laboratory use. General requirements

This declaration is made on behalf of

**GEBRÜDER HEYL**  
**Analysentechnik GmbH & Co. KG**  
**Orleansstraße 75b**  
**31135 Hildesheim**

by

Jörg-Tilman Heyl  
 General Manager

Hildesheim, 17/08/2021

# Check List Testomat 2000®

Dear customers and service technicians,

This check list cannot replace your expertise or extensive experience in fault resolution. It is intended to support fast and systematic error diagnosis and error documentation. This list does not claim to be complete. We are therefore always grateful for any advice and information you may be able to provide. General user instructions can be found on the rear of this check list.

The Instrument Manufacturer

## Block 1 / Plant and instrument data

|            |                 |                |                |                 |          |
|------------|-----------------|----------------|----------------|-----------------|----------|
|            | Testomat 2000®  |                |                |                 |          |
|            | Testomat® ECO   |                |                |                 |          |
| Plant type | Instrument type | Instrument no. | Indicator type | Software status | Pump no. |

## Block 2 / Error message and error history

Please mark appropriately (X)

|  |     |    |                        |
|--|-----|----|------------------------|
| What does your instrument's error history display?<br>("i" and "Enter" key => operating instructions)  |     |    | ( Error history text ) |
| Does an error message appear on the display?<br>For example, "Mf. analysis", "Low water level", etc.<br>(See operating instructions: "Error messages / Troubleshooting") | Yes | No | ( Error message text ) |

## Block 3 / Visual inspection and functional test

Please mark appropriately (X)

If applicable, values / comments

|  |     |    |                 |
|--|-----|----|-----------------|
| Is the instrument connected to the mains voltage specified on the rating plate?                                      | Yes | No |                 |
| Does a message appear on the display?  | Yes | No |                 |
| Does the instrument display a plausible measured value?<br>(possible manual measurement _____ value)                 | Yes | No | Measured value: |
| Are the measuring chamber and sight-glass windows clean?   | Yes | No |                 |
| Are the measuring chamber and the water-carrying hoses free of leaks?  | Yes | No |                 |
| Is the indicator's expiry date still valid?<br>(See expiry date printed on the indicator bottle)                     | Yes | No | Expiry date:    |
| Is the water pressure within the specified range (400 ml/min)?<br>(See the type plate on the instrument)             | Yes | No | Plant pressure: |
| Does the drain hose prevent the risk of backwater?<br>(No "syphoning effect"!!)                                      | Yes | No |                 |
| Is the drain hose free of blockages?<br>(Microorganisms caused by contamination, etc.)                               | Yes | No |                 |
| Does the set flushing time/quantity of flush water ensure that only freshwater is measured?                          | Yes | No | Flushing time:  |
| Are the hoses at the dosing pump free from air bubbles?<br>(Operate the pump manually / Carry out a manual analysis) | Yes | No |                 |

### CARRYING OUT A (MANUAL) ANALYSIS

|  |     |    |                        |
|--|-----|----|------------------------|
| Does the water column rise evenly up to the overflow borehole when filling the measuring chamber (5 mm below the upper edge of the measuring chamber)?<br>(If not: check the water pressure, water throughput/flow controller) | Yes | No |                        |
| Does the indicator pump dose correctly when starting an analysis?<br>(LED at the pump illuminates!)  | Yes | No | No. of dosing strokes: |
| Have the indicator and water been mixed properly in the measuring chamber after the dosing process?<br>Check the magnetic stirring bar! =>see maintenance manual "Adjust mode"   | Yes | No |                        |

### PROGRAMMING DATA / OPERATING CONDITIONS

|  |     |    |   |
|--|-----|----|---|
| Have the limit values been set correctly? (Within the measuring range/according to the performance limit of the plant?)  | Yes | No | Limit values:   |
| Is the Testomat instrument always supplied with mains voltage – except during maintenance work/emergency situations?<br>(Temporary shutdown only via the "Standby" key or the "Stop" input!) | Yes | No | See the "General instructions for operating Testomat 2000® and Testomat® ECO" |

Please refer to "Error messages / Troubleshooting" in the **operating instructions** for further information on error messages and possible causes of faults.

Further functional tests (e.g. overflow detection and amplification setting => "Special function Adjust mode") and service instructions can be found in the **maintenance manual**.

After completing these checks, experience shows that it can be assumed that the checked functions (Block 3) are in effective working order if you have answered all the questions with "Yes". We recommend you to carry out these checks during each inspection or if faults occur.

# Instrument settings

## Caution!

Your settings may be deleted if repairs are carried out. Therefore, note down your instrument settings in the table below before sending the instrument to our service team for repairs. Please enclose a copy of the table with the instrument. If you have noted down the settings, they can be easily re-entered by your service staff once any repairs have been completed.

| Menu                        | Setting |
|-----------------------------|---------|
| <b>MODE OF OPERATION</b>    |         |
| Time-controlled             |         |
| Volume interval             |         |
| External (Start)            |         |
| <b>VOLUME</b>               |         |
| 500 ml bottles              |         |
| 20/5 litres container       |         |
| <b>DISPLAY UNIT</b>         |         |
| Display in mg/l             |         |
| Display in ppm              |         |
| <b>LIMIT VALUES</b>         |         |
| Limit val. 1:               |         |
| Limit val. 2:               |         |
| <b>FLUSH TIMES/INTERVAL</b> |         |
| Internal flush time         |         |
| External flush time         |         |
| Interval pause              |         |
| <b>MEASURING POINTS</b>     |         |
| 1 Measuring point           |         |
| 2 Measuring points internal |         |
| 2 Measuring points external |         |
| <b>TYPE OF WATER METER</b>  |         |
| 1 Litre/Impulse             |         |
| 2,5 Litres/Impulse          |         |
| 5 Litres/Impulse            |         |
| 10 Litres/Impulse           |         |
| 100 Litres/Impulse          |         |
| 500 Litres/Impulse          |         |
| 1000 Litres/Impulse         |         |
| <b>FUNCTION LV1</b>         |         |
| Duration                    |         |
| Impulse                     |         |
| Interval                    |         |
| Two point                   |         |
| Range LV1-LV2               |         |
| Time:                       |         |
| <b>FUNCTION LV2</b>         |         |
| Duration                    |         |
| Impulse                     |         |
| Interval                    |         |
| Time:                       |         |
| <b>HYSTERESIS LV1</b>       |         |
| Analysis (1,2,3)            |         |
| <b>HYSTERESIS LV2</b>       |         |
| Analysis (1,2,3)            |         |
| <b>ALARM/MESSAGE</b>        |         |
| Reagent low level           |         |
| Low water pressure          |         |
| Ff. optics                  |         |
| Ff. dosing pump             |         |
| Ff. outlet to drain         |         |

|                            |  |
|----------------------------|--|
| Mf. dirtiness              |  |
| power failure 24 V         |  |
| Mf. turbid                 |  |
| Meas. range exceeded       |  |
| Maint. int. exceeded       |  |
| Change pump head 1         |  |
| Change pump head 2         |  |
| <b>FUNCTION IN1</b>        |  |
| Normally open contact      |  |
| Normally closed contact    |  |
| <b>FUNCTION STOP</b>       |  |
| Normally open contact      |  |
| Normally closed contact    |  |
| <b>INTERFACES</b>          |  |
| Type 0-20 mA               |  |
| Type 4-20 mA               |  |
| Type RS232                 |  |
| Type Data Logger           |  |
| <b>FUNCTION AUX</b>        |  |
| Contact before analysis    |  |
| Contact during analysis    |  |
| Contact after analysis     |  |
| Time:                      |  |
| <b>OPERATING TIME</b>      |  |
| <b>MAINTENANCE INTERV.</b> |  |
| <b>CUSTOMER SERVICE</b>    |  |
|                            |  |
|                            |  |
|                            |  |





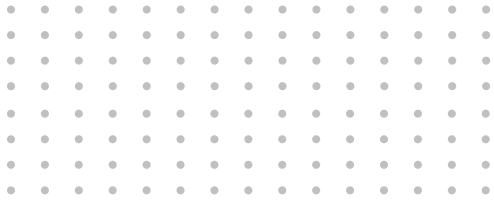

Gebrüder Heyl  
Analysentechnik GmbH & Co. KG  
Orleansstraße 75b  
D 31135 Hildesheim  
[www.heylanalysis.de](http://www.heylanalysis.de)

Testomat\_2000\_PO4\_EN\_230125



Scan the code and  
visit us on our website!